

No.1

WE MAKE IT EASY!



GIFTS THAT DELIGHT

**MODERN AND ECO
PRINT SERVICE**

**SUSTAINABLE MATERIALS
AND PACKAGING**

INDEX



WRITING 1-43



OFFICE 44-71



MOBILE 72-105



HOME & DRINKWARE 106-185



BAGS 186-219



TRAVEL & CARE 220-243



LEISURE 244-273



TOOLS 274-289



PREMIUMS 290-304



PROTECT OUR ENVIRONMENT!

Sustainability is a highly important value for us, and we are committed to using environmentally friendly materials that contribute to reducing the environmental footprint of our products. Therefore, we proudly utilize innovative materials such as jute, RPET (recycled PET), recycled canvas and paper, stainless steel, bamboo, wood, and cork.

The use of these materials allows for a reduction in environmental impact, as many of them come from renewable sources or are made from recycled materials. Recycled materials like RPET or recycled paper, for example, reduce the need for new raw materials and minimize waste in landfills.

These materials are generally of excellent quality and durability, leading to a longer lifespan compared to certain single-use plastic or paper alternatives. This contributes to reduced consumption and increased product durability, ultimately lowering the amount of waste generated.

Additionally, the use of sustainable materials can positively impact the reputation of companies and brands. It showcases a company's commitment to environmental consciousness and responsible business practices, appealing to environmentally conscious consumers and clients.







Protection of the environment is of utmost importance to our company, and we strive to ensure that our packaging is completely free from plastics. It is a key focus for our products not only to represent high quality but also to be sustainable, which is why we use exclusively recycled and recyclable paper in the production of our boxes.

Each box is crafted with a unique design, providing not only an eco-friendly but also an aesthetically attractive appearance. The various boxes complement each other beautifully, making them perfect for sale as sets.



SUBLIMATION





0724

page 198.

Make it your way! By taking advantage of our sublimation products and sublimation print technology! Sublimation is a special printing process that can be advantageous for multicolor or CMYK branding. Sublimation printing is an economical solution, regardless of the number of pieces you want to produce. Sublimation printing ensures outstanding quality as the colors deeply embed into the fabric, making them more resistant to wear and washing.



3825

page 140.



8515

page 202.



3835

page 152.

RECYCLED PAPER

Recycling paper plays an important role in protecting the environment by reducing the need for logging and waste disposal. Recycled paper is produced with lower energy consumption and emits fewer harmful substances into the environment. Recycling allows for multiple uses of paper, which can improve the environmental condition in the long term.

The process of recycling paper involves the following steps: collection, cleaning, shredding, wetting, filtering, and pressing. During the production of recycled paper, paper pieces are mixed with water and chemicals to facilitate filtering and pressing. The paper pulp is evenly distributed during pressing and then dried to create the recycled paper.



2565

Ball pen Amsterdam

Blue writing ball pen made from recycled paper, the coloured applications are made from corn. Your logo is printed to the right of the clip.

✎ 14,5 × ø 0,9 cm

☒ T1

☒ 4 × 0,5





ECO



METAL



RECYCLED PAPER



BLUE REFILL



1957

Cardboard ball pen Cramlington

Blue ink ballpen made of recycled cardboard, with corrugated metal clip and plastic tip, packed in a cardboard case. We will print your logo below the clip.

✂ 15,4 × 2,7 × 0,8 cm

☒ T2

☑ 4 × 0,6



ECO



WHEATSTRAW



RECYCLED PAPER



BLUE REFILL



1472

Paper pen Lennox

Ballpen made of recycled cardboard, with blue writing refill. All applications are made of sustainable wheatstraw. We print your logo on the shaft.

✂ ø 1 × 14,5 cm

☒ T1

☑ 4 × 0,6



ECO



ABS



RECYCLED PAPER



BLUE REFILL



1436

Paper pen Blackpool

Ballpen made of recycled cardboard with silver applications and blue writing refill. We print your logo on the shaft.

✂ ø 0,9 × 14,6 cm

☒ T1

☑ 4 × 0,6



ECO



ABS



RECYCLED PAPER



BLUE REFILL



03

04

05

06

09

10



0397

Paperpen

Ballpoint pen made of recycled paper and colored plastic applications, blue writing. Your logo is printed to the right of the clip.

✂ ø 1 × 14,3 cm

☒ T1

☑ 4 × 0,6

INKLESS PEN

Inkless pens are a new generation writing tool that represents a revolutionary approach compared to traditional ink pens or ballpoint pens. As the name suggests, these pens do not require either ink cartridges or ink for use.

The uniqueness of inkless pens lies in a special composition layer located at the tip of the pen, which interacts with the microstructure of the paper. When we press the tip of the pen onto the paper, it leaves a mark. This process is similar to drawing with a pencil, but with inkless pens, there is no need to sharpen the tip, and the writing or drawing is much smoother and more uniform.

The advantage of inkless pens is that we don't have to worry about refilling ink. Inkless pens write without leaving a trace, so we don't have to fear ink stains or smudges. The pens are also durable, as the composition layer has a long lifespan and doesn't wear out as easily as traditional pen tips.



03

07



03

04

05

09

13



3648

Inkless pen Irvine

Environmentally friendly writing pencil made of paper with erasable writing. The lead is made of a mixture of graphite and metal, which makes it extremely durable. We print your logo on the barrel.

✎ 15,7 × 1,8 × 0,9 cm

☒ T1

☑ 4 × 0,5



3663

Inkless pencil Halmstad

Aluminum inkless pen with touch function and scale in cm and inch. The lead is made of a mixture on graphite and metal, which makes it extremely durable. Your logo will be engraved on the free space on the barrel.

✎ ø 0,9 × 15 cm

☒ L1

☑ 4 × 0,5



3739

Inkless pen Helsingborg

Inkless ball pen made of bamboo. The lead is made of a mixture of graphite and metal, making it extremely durable. We laser engrave your logo to the right side of the clip

- ✎ ø 1,1 × 14,3 cm
- ⊗ L1
- ☞ 5 × 0,6



0641

Ballpen Concepción

Ballpoint pen made of bamboo with blue writing large capacity refill. The finishing is done by laser engraving below the clip.

- ✎ ø 1,1 × 13,9 cm
- ⊗ L1
- ☞ 4 × 0,7



0640

Writing set Port-au-Prince

Writing set made of bamboo, including a blue-writing ballpen and a mechanical pencil in a cardboard case. We engrave your logo below the clip on both pens.

- ✎ 17 × 4 × 2,2 cm
- ⊗ L6
- ☞ 4 × 0,7

ECO BAMBOO BIG BLUE REFILL



0457

Ballpen Brentwood

Bamboo ballpen with blue-writing refill. We engrave your logo below the clip.

✍️ ø 1,2 × 14 cm
🌀 L1
📏 4 × 0,6



ECO BAMBOO, METAL BIG BLUE REFILL



2193

Bamboo Ballpen Beringen

Bamboo Ballpen with push mechanism. Features a blue-writing big refill and applications in atracite. Your logo will be lasered on the right side next to the clip.

✍️ ø 1,2 × 14 cm
🌀 L1
📏 4 × 0,7

ECO MAPLE WOOD, METAL BIG BLUE REFILL



1291

Wooden ballpen Palmdale

Handy, black writing ballpen made of wood with black plastic cap. Your logo will be engraved.

✍️ ø 0,7 × 15,1 cm
🌀 T1
📏 4 × 0,6

ECO BEECH WOOD, PLASTIC BLACK REFILL



1892

Wooden ball pen Heywood

Classic wood pen with a blue-writing plastic refill and a cardboard case. We engrave your logo below the clip.

✍️ 15,4 × 2,7 × 0,9 cm
🌀 L2
📏 4 × 0,5





ECO



BAMBOO,
WHEATSTRAW



BLUE REFILL



03 04 05 06 09 10

3211

Wheatstraw and bamboo ballpen Halle

Retractable bamboo ballpen with coloured wheatstraw applications and a blue-writing refill. Your logo will be printed to the right side next to the clip.

- ✎ ø 1 × 14,2 cm
- ✂ T1
- ☞ 4 × 0,6

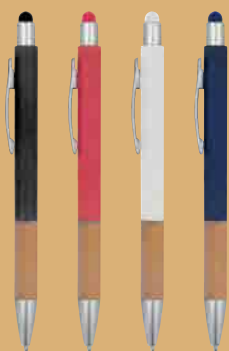

03 05 06 44



ECO



BAMBOO, ABS



TOUCHPEN



BLUE REFILL



2642

Ballpoint with touch function Tripoli

Retractable ballpoint pen with a bamboo grip zone, touch function and blue refill. We print your logo next to the clip.

- ✎ ø 1 × 14,7 cm
- ✂ DC0
- ☞ 4 × 0,6



ECO



BEECH WOOD,
METAL



BLUE REFILL



1437

Metal wooden gift set Enschede

Set including a ballpen and keyring in a wood-metal combination. Your logo will be engraved on both wooden surfaces in one size.

- ✂ 16,3 × 9 × 1,9 cm
- ✂ L6
- ✂ 3,5 × 0,6



ECO



WOOD



TOUCHPEN



BIG BLUE REFILL



2192

Wooden Ballpen Bilzen

Wooden ballpen with push function, blue-writing big refill, chrome applications and touch function. Your logo will be engraved on the right side next to the clip.

- ✂ ø 1,2 × 14,5 cm
- ✂ T2
- ✂ 4 × 0,6



ECO



OLIVE WOOD,
METAL



TOUCHPEN



BLACK REFILL





1497

Wooden ballpen with touch function Erfurt

Ballpen made of olive wood, with touch function and blue writing refill. Your logo will be engraved below the clip.

- ✂ ø 1 × 14,7 cm
- ✂ L1
- ✂ 4 × 0,6





- 
 ECO
- 
 BAMBOO
- 
 TOUCHPEN
- 
 6 IN 1,
 BLACK REFILL



3040

6in1 multifunction pen Coimbra

Practical 6in1 multifunction bamboo pen with the following features: Twist ballpoint pen with black writing system refill, ruler, spirit level, slotted and Phillips screwdriver and a touch pen. We engrave your logo on the barrel.

-  ø 1 x 15,5 cm
-  L1
-  5 x 0,5



02 03 04 05 06 07 09 10 11 24 29

3690

Ballpen Capri

Metal ball pen with golden applications, blue-writing refill and cork grip zone. Your logo will be engraved to the right of the clip.

- ✂ $\varnothing 1 \times 15$ cm
- ☒ L1
- ☒ 4 x 0,6



1424

Cork pen Breda

Retractable ballpen with cork barrel and elegant silver applications, blue writing refill. We print your logo on the shaft.

- ✂ $\varnothing 0,9 \times 14,1$ cm
- ☒ L1
- ☒ 4 x 0,6



ECO



CORK



BLUE REFILL



3236

Twist-ballpen metal and cork Lillehammer

High-quality twist-action metal ballpoint pen with cork coating, blue-writing refill in a case that is also made of cork. Your logo will be engraved next to the clip.

✍️ 17,5 × 5,5 × 2,5 cm

📏 L1

📦 4 × 0,6

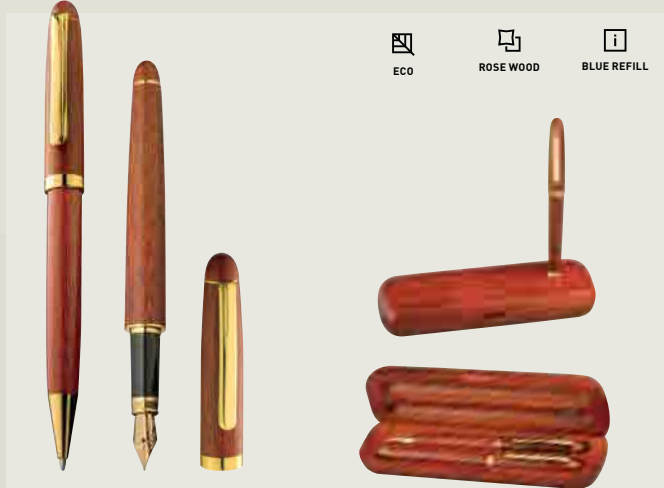



 ECO
  ROSE WOOD
  BLUE REFILL

4015

Rosewood writing set Oxford

Rosewood writing set consisting of a twist action ballpoint pen with blue writing metal refill and a fountain pen delivered in a wooden case. We laser your logo on the wooden box.

-  17 × 5,5 × 2,4 cm
-  L3
-  5 × 3

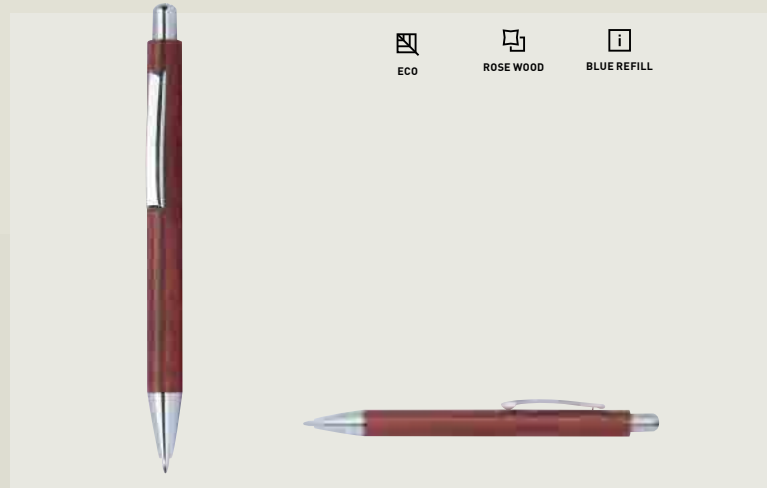



 ECO
  ROSE WOOD
  BLUE REFILL

2528

Wooden pen Posadas

Wooden pen with blue writing refill, silver applications and push mechanism. Your logo will be engraved on the right of the clip.

-  ø 1 × 14,2 cm
-  L1
-  4 × 0,6





 ECO
  ROSE WOOD
  BLUE REFILL

8441

Rosewood writing set Bangkok

The rosewood set includes: a wooden ballpen with twist mechanism and blue-writing metal refill, a wooden fountain pen with blue-writing cartridge, and a letter opener. Your logo will be engraved on the box.

-  17 × 7,5 × 2,3 cm
-  L3
-  5 × 3





ECO



MAPLE WOOD



BLUE REFILL



0614

Wood writing set Rambin

Wooden writing set consisting of a blue-writing ballpoint pen and a blue-writing rollerball in a case. We engrave your logo on the case.

- ✂ 17,2 × 5,5 × 2,4 cm
- ☒ L6
- ☒ 4 × 0,6



ECO



BEECH WOOD,
METAL



BLUE REFILL



0646

Ballpen Ipanema

Wooden ballpen with blue-writing metal system refill and a wooden case. The laser engraving is mounted below the clip.

- ✂ 17,4 × 2,7 × 2,3 cm
- ☒ L1
- ☒ 4 × 0,7



ECO



BEECH WOOD,
METAL



BLUE REFILL



0643

Ballpen Yellowstone

Twist mechanism wooden ballpen with blue-writing metal refill and wooden case. Your logo is engraved below the clip.

- ✂ 17 × 2,8 × 2,3 cm
- ☒ L1
- ☒ 3,5 × 0,6



METAL

3614

Metal writing set Karlovac

Writing set consisting of a twist ballpoint pen with blue writing system refill and a blue writing rollerball made of aluminum in a case. The chrome applications and the sparkling decorative rings give the set its elegant look. Your logo will be engraved on both pens to the right of the clip.

- ✎ 18 × 5,8 × 3 cm
- ✎ L4
- ☒ 3 × 0,6



METAL



BLUE REFILL



3616

Ballpen Kapfenberg

Twist action ballpoint pen made of aluminum with blue writing system refill. The chrome-plated applications and the sparkling decorative ring give the pen its special look. Your logo is engraved on the right side of the clip.

- ✎ ø 1,1 × 13,6 cm
- ✎ L1
- ☒ 3 × 0,6



METAL

BLACK & BLUE
REFILL



1934

Writing set Mayfiled

Writing set consisting of a high-quality case with flap, a ballpoint pen with a large black plastic refill and a fountain pen. Your logo will be lasered onto both writing instruments. Laser price for both writing instruments.

- ✂ 16,4 × 3,9 × 2,2 cm
- ✂ L4
- ✂ 3 × 0,6

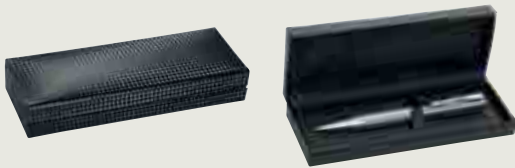

METAL

BIG BLUE
REFILL



3035

Metal ball pen Chester

Elegant metal ballpoint pen with blue-writing metal refill. The beautiful set is completed by a chic gift box. We engrave your logo below the clip.

- ✂ 17,1 × 6,5 × 3 cm
- ✂ L2
- ✂ 4 × 0,6



METAL

BIG BLUE
REFILL



8413

Metal ball pen Clayton

High-quality metal pen in matt black, with shiny silver applications, and elegant case. We will engrave your logo below the clip.

- ✂ 18 × 7,5 × 2,3 cm
- ✂ L2
- ✂ 3,5 × 0,6



PLASTIC

3 IN 1, BLUE REFILL,
CALLIPER, RULER



1972

Plastic Ball pen with sliding calliper Prescott

Plastic ballpoint pen with ruler and calliper. We print your logo opposite to the scale.

- ✂ 14,7 × 1,2 × 0,9 cm
- ⊗ T2
- ☒ 4,5 × 0,8



METAL

RED & BLUE REFILL,
LED, LASER POINTER

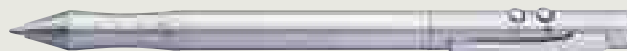

2798

Laser pointer Matlock

Laser pointer. Metal pen with red and blue writing refills, laser pointer, and LED; includes three button cell batteries and a metal box. Your logo will be engraved.

- ✂ ∅ 1 × 15,4 cm
- ⊗ L2
- ☒ 3,5 × 0,6

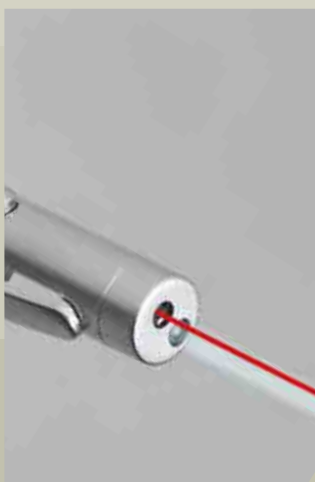

METAL

BLUE REFILL, LED,
LASER POINTER



5318

Metal laser pointer Detroit

Ballpen with laser pointer and LED light, packed in an individual box; three button cell batteries included. Your logo will be engraved.

- ✂ ∅ 0,9 × 13,6 cm
- ⊗ L2
- ☒ 4 × 0,6



TOUCHPEN



ALUMINIUM

2974

Ball pen with touch function Catania

Metal ballpen with blue-writing plastic refill and color-matched touch function above the clip. We will engrave your logo below the clip.

✎ ø 0,8 × 13,8 cm

☒ L1

☒ 4 × 0,4



95



07



98

GEL INK & SEMI-GEL INK

Gel-based ballpoint pens, or gel ink pens, are popular writing instruments used for writing and drawing. They come in two main types: traditional gel ink pens and semi-gel ink pens. Traditional gel ink pens store ink in a reservoir or cartridge and dispense it using a ball or cylinder. Semi-gel ink pens typically mix the ink with a special substance for a more liquid and easy writing experience.

Gel ink pens are comfortable, easy to use, and provide a smooth writing experience. The ink dries quickly, reducing the likelihood of smudging. They offer a wide range of colors for vibrant writing and are great for detailed work.

Overall, gel-based ballpoint pens are versatile and practical tools for clean and smooth writing. They are favored by those seeking style and comfort in their writing instruments.

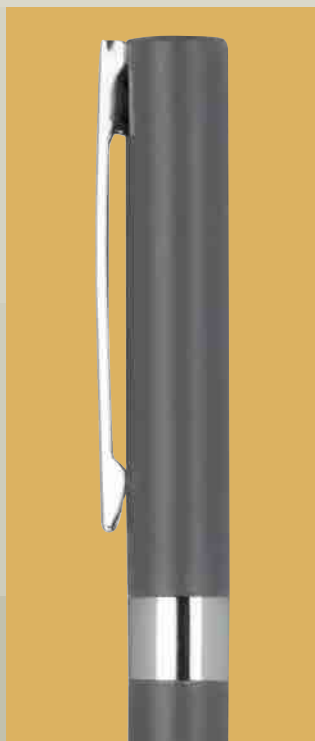

3742

Gel pen Huelva

Aluminium gel pen with blue gel refill (0.7 mm tip). We engrave your logo to the right side of the clip.

✍️ ø 1 × 14,5 cm

📏 L1

📏 4 × 0,7



 ALUMINIUM

 SEMI-GEL INK,
BLUE REFILL

03 04 05 06 09 10 11 14 77

3741

Metal Ballpoint Pen Almeida

Metal ball pen made of aluminium with blue semi-gel refill (1 mm tip) and ribbed grip zone. We laser your logo to the right side of the clip.

✍️ ø 1 × 14,2 cm

☒ L1

☒ 5 × 0,6





RUBBERIZED PEN

Rubberized metal pens are elegant and practical writing instruments that combine functionality and style. The body of these pens is usually metal covered with a rubberized coating. This rubberized surface provides a comfortable grip and stable control while writing.

The metal base color can be brought out through a pattern or text engraved in the body of the pen, which gives the pen an elegant and clean look.

 RUBBER COATED,
BLUE REFILL

 METAL, RUBBER

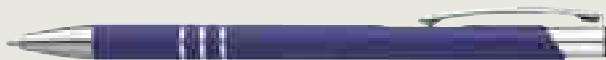

TOP PRICE



03 04 05 06 08 09 10 14 77

0555

Metal ballpen New Jersey

Slim metal ballpen with rubber finish and blue writing plastic refill. Your logo will be engraved below the clip.

 ø 0,8 × 13,5 cm

 L1

 4 × 0,6

 RUBBER COATED,
BIG BLUE REFILL

 METAL, RUBBER



TOP PRICE



03 05 06 44 99

3655

Ballpen Glendale

TOP PRICE! Ball pen made of aluminum with gold applications, rubber finish and blue writing large capacity refill. Your logo will be lasered on the right side of the clip, it will appear in gold color.

 ø 1 × 14,2 cm

 L1

 4 × 0,6

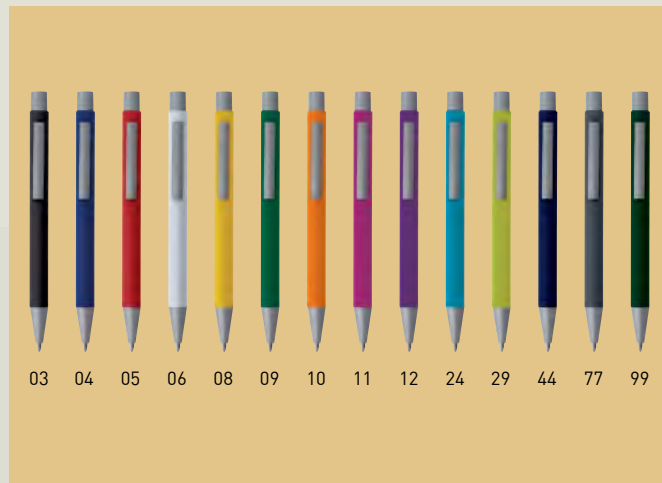

 RUBBER COATED,
BIG BLUE REFILL

 METAL, RUBBER





TOP PRICE

0935

Metal ballpen Abu Dhabi

TOP PRICE! Metal retractable ballpoint pen with rubber finish surface and large capacity blue ink refill. We laser your logo on the right side of the clip

 ø 1 × 14 cm

 L1

 5 × 0,5

 RUBBER COATED,
BIG BLUE REFILL

 METAL, RUBBER

 TOUCHPEN



TOP PRICE



03 04 05 06 08 09 10 11 12 24 29 44 77 99

0934

Ballpen with touch functions Salt Lake City

TOP PRICE! Metal ball pen with rubber finish surface, touch pen and blue writing large capacity refill. We laser your logo on the right side of the clip.

 ø 1 × 14,7 cm

 L1

 5 × 0,5



TOP PRICE

 BIG BLUE REFILL

 METAL

3330

Metal pen & pencil set

Writing set made of aluminum, consisting of a ballpoint pen with blue writing large capacity refill and a mechanical pencil, each with decorative rings. Your logo will be engraved to the right of the clip.

 17,5 × 5,7 × 2,2 cm

 L6

 4 × 0,6

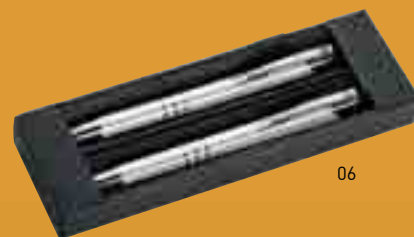

06



05

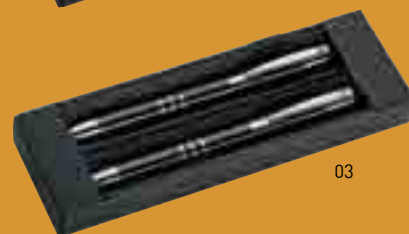

03



04

 METALLIC COLOR,
BIG BLUE REFILL

 METAL



TOP PRICE



02 03 04 05 06 08 09 10 11 12 14 29 77

3339

Metal ball pen Ascot

Metal pen with blue-writing refill. We will engrave your logo below the clip.

✂ $\varnothing 1 \times 13,6$ cm

✂ L1

✂ $4 \times 0,6$

METALLIC COLOR



SOLID COLOR



 SOLID COLOR,
BIG BLUE REFILL

 METAL



TOP PRICE



02 03 04 05 06 07 08 09 10 11 12 14 24 29 44 77

3639

Ballpen Las Palmas

TOP PRICE! Fully lacquered metal ballpen with 3 decorative rings and blue-writing refill with large capacity. Your logo will be engraved to the right of the clip.

✂ $\varnothing 1 \times 14,2$ cm

✂ L1

✂ $4 \times 0,6$



TOP PRICE

 BLUE REFILL

 METAL





04 05 07 09 10

2762

Metal ball pen Itabela

Slim metal ballpen with blue-writing refill and engraved grip zone. We engrave your logo below the clip.

-  $\varnothing 0,9 \times 13,9$ cm
-  L1
-  4 x 0,5



 BLUE REFILL

 METAL

 TOUCHPEN





03 04 05 06 09

0418

Metal-Touchpen

Twist ball metal pen with touch function and blue writing refill. 8 engraved rings make the writing convenient. Your logo will be laser engraved below the clip.

-  $\varnothing 0,9 \times 12,8$ cm
-  L1
-  4 x 0,6

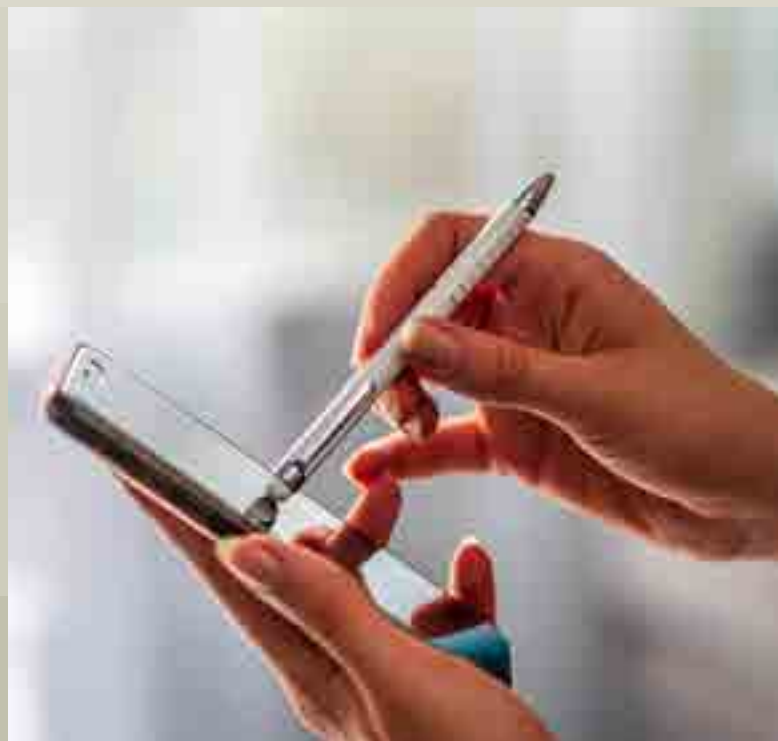



 BLUE REFILL

 ALUMINIUM



 TOUCHPEN



3378

Ball pen with touch function New Orleans



Stainless steel ballpen with blue-writing plastic refill and color-matched touch function above the clip. We will engrave your logo above the clip.

-  ø 0,8 × 13,8 cm
-  L1
-  4 × 0,4

3549

Metal ball pen Port Elizabeth

Elegant aluminum ballpen with blue-writing parker system mine. We engrave your logo below the clip.

-  ø 1,1 × 13,7 cm
-  L1
-  3 × 0,6

 BLUE REFILL



 METAL



0488

Metal ball pen Kings Park

Slim ballpen made of metal with blue writing refill. The crown and the small glass diamond make this pen unique. We engrave your logo to the right of the clip.

-  ø 0,8 × 14,4 cm
-  L1
-  3,5 × 0,4

 BLUE REFILL

 METAL



 **BIG BLUE REFILL**

 **PLASTIC**





03 04 05 06 07 09 10

0461

Ballpen Baltimore

Plastic ballpen with blue-writing plastic refill and silver applications. Your logo will be printed below the clip.

-  $\varnothing 1 \times 13,8 \text{ cm}$
-  T1
-  4 x 0,7



 **BLUE REFILL**

 **PLASTIC**





03 04 05 06

0894

Ballpen Epping

Metallic-looking plastic ballpen with large capacity refill and push function. We will print your logo below the clip.

-  $\varnothing 1 \times 14,5 \text{ cm}$
-  T1
-  4 x 0,6





 **BIG BLUE REFILL,**
RUBBER COATED

 **PLASTIC, METAL**



0099

Ballpen Brescia

Plastic ballpen with rubber finish and blue-writing refill. We engrave your logo on the metal clip.

 ø 1,1 × 14,4 cm

 L1

 3,5 × 0,6





RPET

RPET is produced by recycling PET waste, which is collected, cleaned, shredded, and recycled. The use of RPET reduces the consumption of underground oil and the amount of plastic waste, and improves the environmental impact.

RPET products have the same quality as products made from original PET, and there are many applications for them, such as beverage packaging, clothing, sports equipment, and promotional products.



2554

Transparent ball pen Glasgow

Environmentally friendly, transparent ball pen made of RPET with blue writing large capacity refill, straight clip, printing mechanism and RPET logo. Your logo is printed on the right of the clip.

✍️ ø 1 × 14,7 cm

☒ T1

☑️ 4 × 0,6



24

66

2552

Transparent ball pen Alken

Classic ball pen made of recycled PET, transparent with silver applications and blue writing large capacity refill. Your logo will be printed to the right of the clip.

✍️ 14,6 × ø 1,2 cm

☒ T1

☑️ 4 × 0,6



ECO



RECYCLED ABS



BIG BLUE REFILL



03

04

05

06

08

09

10

11

14

29

3749

Recycled ABS Ballpen Lima

Ball pen made of recycled ABS with rubber grip zone and big refill. We print your logo on the right side of the clip.

✎ ø 1,3 × 14,6 cm

☒ T1

☒ 4 × 0,6



 BLUE REFILL

 PLASTIC



04 05 06 09

 TOP PRICE



0782

Ballpen Jekaterinburg

Slim plastic ballpen with blue-writing plastic refill and rubberized grip zone. Your logo will be printed below the clip.

- ✎ ø 1,1 × 13,7 cm
- ☒ T1
- ☒ 4 × 0,5

 BIG BLUE REFILL

 PLASTIC



 TOP PRICE



03 04 05 06 08 09 10

1679

Ball pen Wladiwostock

TOP PRICE! Ball pen with blue writing large capacity refill. We print your logo on the right side of the clip.

- ✎ ø 1,3 × 14,5 cm
- ☒ T0
- ☒ 4 × 0,6

 BIG BLUE REFILL

 PLASTIC



 TOP PRICE



03 04 05 08 09 10 11 12 44

1683

Plastic ball pen Kaliningrad

TOP PRICE! Ballpoint pen with white barrel, metal clip, blue writing large capacity refill and colored soft touch grip zone. We print your logo on the right side of the clip.

- ✎ ø 1,3 × 14,5 cm
- ☒ T0
- ☒ 4 × 0,6



TOP PRICE



PLASTIC



BLUE REFILL



02 03 04 05 06 08 09 10 11 12 14 24 29 44

1682

Plastic ball pen Moscow

TOP PRICE! Transparent ball pen with soft touch grip zone and blue writing large capacity refill. We print your logo on the right side of the clip.

- ✂ ø 1,3 × 14,5 cm
- ✂ T0
- ✂ 4 × 0,6



TOP PRICE



BIG BLUE REFILL



PLASTIC

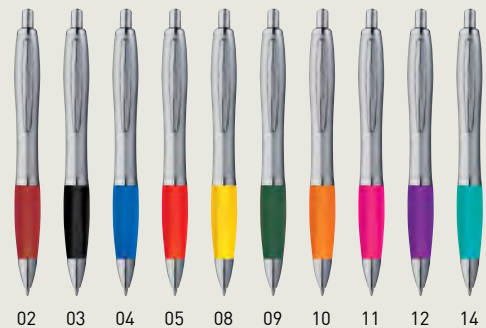

02 03 04 05 08 09 10 11 12 14

1681

Plastic ball pen St. Petersburg

TOP PRICE! Ballpoint pen with blue writing large capacity refill and color contrast soft touch grip zone. We print your logo on the right side of the clip.

- ✂ ø 1,3 × 14,5 cm
- ✂ T0
- ✂ 4 × 0,6



 BLUE REFILL
 PLÁSTIC



7899

Plastic ball pen Mao

Not just black and white! This colourful ball pen got lots of space for your multicoloured logo. The grip zone is made for a nice and easy handling. We will pad print your logo onto the shaft.

- ✂ $\varnothing 1 \times 14,2$ cm
- ☒ T1
- ☒ 4 \times 0,6



 BLUE REFILL
 PLÁSTIC





3539

Plastic ball pen Fairfield

Plastic ballpoint pen with rotating mechanism and blue-writing plastic refill. We print your logo on the shaft.

- ✂ $\varnothing 1,2 \times 14,3$ cm
- ☒ T1
- ☒ 4 \times 0,8



 BLUE REFILL
 PLÁSTIC

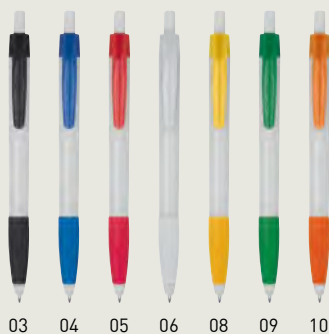

3781

ball pen Newport

Ball pen with coloured accents and a rubber grip zone. The ballpen has a blue writing plastic refill. We print your logo to the right side of the clip.

- ✂ $\varnothing 1 \times 1,4$ cm
- ☒ T1
- ☒ 4 \times 0,6



 PLÁSTIC
 BLUE, RED, BLACK REFILL, 4IN1
 TOUCHPEN

0458

4in1 Ballpen Bogotá

4in1 plastic ballpen with 3 different writing colors (blue, red and black) + touch function and rubberized grip zone. We print your logo on the shaft.

- ✂ $\varnothing 1 \times 15$ cm
- ☒ T1
- ☒ 4 \times 0,7

METAL, PLASTIC
BLUE REFILL



1292

Mobile phone holder with metal ballpen Regina

Mobile phone holder with anti-slip base, magnetic function, and blue-writing metal ballpen. Your logo will be printed on the front.

- ✂ 7 × 8,5 × 15,7 cm
- ☒ T3
- ☒ 3 × 2

BLUE OR RED
REFILL
PLASTIC



04

05



1089

Plastic ball pen Syringe 1

Gag pen in the shape of a syringe, with blue or red plastic writing refill. We will print your logo in black, opposite to the scale.

- ✂ ø 1,2 × 12,7 cm
- ☒ T1
- ☒ 3 × 0,6



PLASTIC
BLUE REFILL,
2 IN 1, SPRAY



1776

Twistpen with sprayer Charleroi

Translucent Twistpen with silver applications and blue-writing refill. The sprayer is refillable - perfect for perfume or disinfection fluids. We print your logo on the right side of the clip.

- ✂ ø 1,4 × 16,5 cm
- ☒ DC0
- ☒ 5 × 0,5



PLASTIC
4 WRITING COLOURS,
4 IN 1

03

04

05

29



0789

4in1 Ballpen Neapel

Plastic ballpen with 4 colored writing mines (blue, black, red, and green.) Your logo will be printed below the clip.

- ✂ ø 1,8 × 14,5 cm
- ☒ T1
- ☒ 3 × 0,6



2678

Pencil case Munich

Versatile pencil case made of 72% jute and 28% cotton. It creates order and offers space for everything you need on the go. We will print your logo on one page.

- ✂ 19 × 4,2 × 6,8 cm
- ☒ TT1
- ☒ 10 × 3



3588

Pencil case Lustenau

Cotton pencil case with plenty of space for crayons, pencils, pens, fillers, sharpeners, erasers, etc. Your logo will be printed on one side.

- ✂ ø 7,5 × 22,5 cm
- ☒ TT1
- ☒ 12 × 4



3773

RPET Pencil Case Neuchâtel

Pencil case made of recycled 600D polyester with zipped front compartment and carrying handle. It is the perfect companion whether as a pencil case or cosmetics case. We print your logo on the front below the zip.

- ✂ 20,5 × 3,7 × 8,5 cm
- ☒ TT1
- ☒ 12 × 5



03



13



ECO



PAPER



0929

Gift box for a ballpen Valladolid

Gift box with space for a pen, present your pen in a noble look. We will print your logo on the box.

✂ 17 × 4 × 2,5 cm

📦 T3

📏 5 × 2



ECO



52 PIECES



PLASTIC, PAPER



1142

Painting set for kids Fun

In this large painting set you will find fun for young and old. Includes colored pencils, pencils, markers, crayons, paint box, eraser, sharpener, and plastic paper clip; packed in a foldable decorative box. We will stick your logo on a label on the box.

✂ 17,5 × 10 cm

📦 S1

📏 8 × 8



ECO



65 PIECES



PINE (WOOD)



1134

Big wooden painting set Maxi

Large painting set including colored pencils, crayons, chalks, paint box, ruler, eraser, sharpener, and glue. We print your logo by pad printing on the case.

✂ 28 × 21 × 4,3 cm

📦 L3

📏 10 × 5



0493

Colouring book

Coloring book folder with recycled cover, paint block (30 sheets), carrying holder, sharpener, eraser, and crayons in 6 different colors. Your logo will be printed on the cover.

✂ 20,5 × 20,7 × 1,5 cm

📏 T3

📦 5 × 5

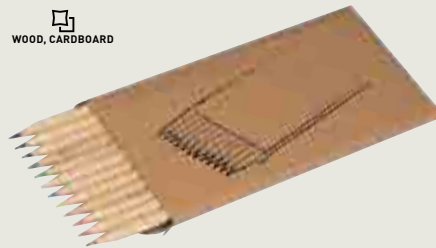

3164

12-piece crayon set Menorca

Eco-friendly wooden crayon set in cardboard packaging with 12 different coloured crayons. Your logo will be printed on the packaging.

✂ 18 × 8,9 × 0,8 cm

📏 T2

📦 3 × 3



1127

Wooden crayons Minnie

6 short crayons in a cardboard case. We will pad print your logo on top of the cardboard in your desired color.

✂ 9,3 × 4,9 × 0,9 cm

📏 T2

📦 4 × 3



1132

Wooden crayons Becky

Cardboard box with six short, thick colored pencils and integrated sharpener with blue transparent plastic lid. We will pad print your logo on the box.

✂ ø 2,7 × 10 cm

📏 T2

📦 5 × 1,5

ECO PAPER, BASSWOOD, PLASTIC 13 PIECES



1125

Drawing set for kids Little Picasso

Painting set including 10 colored pencils, plastic ruler (15 cm), plastic sharpener, and various pre-printed motifs for coloring. We will pad print your logo on the cardboard box.

- ✂ 18 × 7,5 × 0,8 cm
- ☒ T2
- ☑ 3 × 2,5

ECO WOOD, CARDBOARD 6 PIECES



3216

Writing set Hamburg

Writing and drawing set including 3 pencils with different degrees of hardness, ruler, eraser and sharpener. Your logo will be placed on the single packing.

- ✂ 17,8 × 5 × 1,2 cm
- ☒ T2
- ☑ 3 × 3

19 PIECES ALUMINIUM, WOOD



3579

Writing set Kyoto

16 different coloured crayons with eraser and sharpener in a lockable metal box. Your logo will be engraved on the box.

- ✂ ø 4,7 × 9,1 cm
- ☒ L2
- ☑ ø 3,5

ECO ERASER, UNSHARPENED BASS WOOD



0393

Pencil with rubber

Wooden pencil with eraser and HB mine. We print your logo on the pencil below the eraser.

- ✂ ø 0,7 × 19,1 cm
- ☒ T1
- ☑ 4 × 0,3



0746

XXL Highlighter Colorado

XXL highlighter in various bright colors. With this, your advertising is guaranteed to stand out not only on any desk. Due to its size, the highlighter offers extra space for your logo. We print this on the shaft. All-round printing possible on request.

- ✂ $\varnothing 2,2 \times 22,6$ cm
- ☒ T3
- ☑ $9 \times 1,2$



0301

Metal duo pen Getafe

Aluminum ballpoint pen with black-writing refill and yellow highlighter on the opposite side. We engrave your logo on the shaft.

- ✂ $\varnothing 1 \times 14$ cm
- ☒ L1
- ☑ $4 \times 0,6$

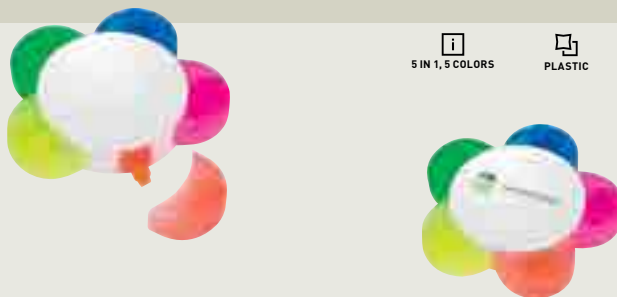

0679

5in1 Highlighter Butterworth

Highlighter with five different colors and large advertising space in the middle. We print your logo in the middle of the highlighter.

- ✂ $9,6 \times 9,6 \times 1,8$ cm
- ☒ T2
- ☑ $\varnothing 3,5$

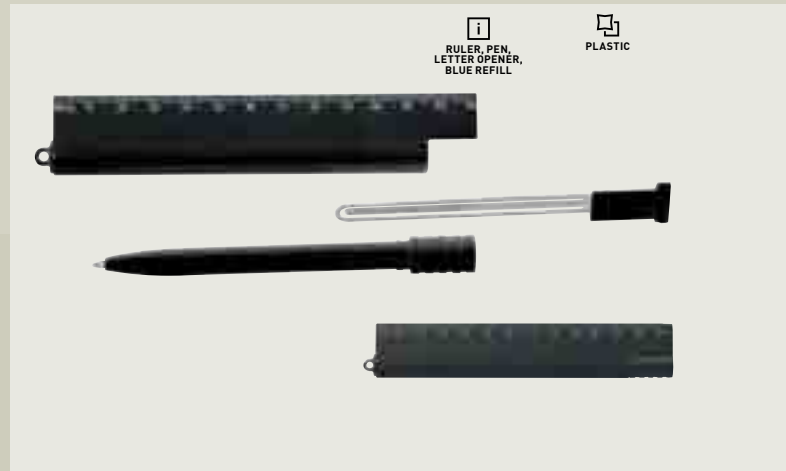

3767

Multifunctional Ruler Manila

3in1 multifunctional ruler made of plastic. In addition to the ruler, it also has an integrated blue-writing ball pen and a metal bookmark. We print your logo below the scale on the ruler.

- ✂ $14,3 \times 2,5 \times 1,2$ cm
- ☒ T2
- ☑ 5×1



0896

Pencil Eisenstadt

Mason pencil with printed measuring scale on one side. We print your logo opposite to the scale.

✂ 17,8 × 1,2 × 0,7 cm

🔍 T1

📏 5 × 0,8



04 05 06



3585

Carpenter pencil Kent

Large carpenter pencil with wooden coating and graphite lead. The pencils are delivered unsharpened. Your logo will be printed on the pencil.

✂ 17,7 × 1 × 0,6 cm

🔍 T1

📏 4 × 0,7



04 05 06



0539

Carpenter's pencils Szeged

Large, rectangular carpenter's pencil in wood and graphite HB mine (delivered sharpened.) We will print your logo on the pencil.

✂ 24 × 1,2 × 0,7 cm

🔍 T1

📏 4 × 0,9



CORK, PAPER, PU

A5, 160 LINED PAGES

PEN LOOP



1395

A5 Notebook Nantes

A5 notebook with 160 lined pages and PU cork cover, bookmark, ballpen loop, and elastic closure band. We print your logo on the front.

✂ 14,3 × 21 × 1,8 cm
✂ T3
✂ 5 × 3



ECO

CORK

A5, 192 LINED PAGES

RECYCLED PAPER

2459

A5 notebook Mesen

A5 notebook with cork cover and 192 recycled lined pages. We will print your logo on the cover.

✂ 13,9 × 20,9 × 1,6 cm
✂ TT1
✂ 10 × 15





CORK, PAPER,
WHEATSTRAW

A5, 160 DOTTED
PAGES



PEN LOOP,
PEN INCLUDED,
BLUE REFILL



2188

A5 Notebook Bastogne

A5 Notebook in cork cover with 160 dotted pages, elastic strap, pen loop and a wheatstraw ball pen with cork coating in a cardboard box. The Logo will be printed onto the book.

 17,3 × 23,5 × 1,8 cm

 T3

 5 × 3



ECO



BAMBOO



A5, 160 LINED
PAGES



PEN INCLUDED,
BLUE REFILL



RECYCLED PAPER

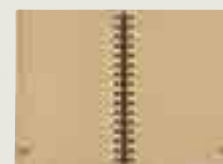
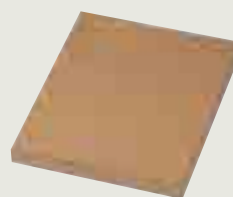

2699

A5 notebook Pisa

Chic eco set consisting of a DIN A5 notebook with a bamboo cover, spiral binding and 160 lined pages made of recycled paper as well as a bamboo ballpoint pen with a blue plastic refill and plastic applications. We will engrave your logo on the outside of the notebook cover.

✂ 23,8 × 19,7 × 2,1 cm

📦 L2

📦 6 × 4



ECO



BAMBOO



160 LINED PAGES



RECYCLED PAPER

2740

Notebook Phoenix

Small spiral bound notebook, bamboo cover and 160 lined pages made from recycled paper. We will engrave your logo on the front of the cover.

✂ 12,1 × 10 × 1,8 cm

📄 L2

📦 6 × 4



ECO



CARDBOARD



A5, 160 LINED PAGES



PEN LOOP



RECYCLED PAPER

3217

Cardboard notebook silkeborg

Cardboard notebook with spiral binding, 160 recycled lined pages, pen loop and elastic strap closure. Your logo will be printed on the front.

✂ 15,3 × 1,8 × 21,2 cm

📄 S1

📦 15 × 10





 RECYCLED PAPER

 A6, 120 LINED PAGES



 PEN INCLUDED,
BLUE REFILL



1976

A6 ECO Notepad Keystone

Recycled cardboard notepad with 120 pages of recycled paper and a blue ink ballpoint pen. We will print your logo on the cover.

-  11 × 14,5 × 0,6 cm
-  T3
-  5 × 3

 RECYCLED PAPER

 A5, 120 LINED PAGES



 PEN INCLUDED,
BLUE REFILL



1907

A5 ECO Notepad Kentwood

A5 writing pad made of recycled cardboard and paper with 120 lined pages and a blue ink ballpen made of recycled cardboard. We print your logo on the cover.

-  15 × 21 × 0,5 cm
-  T3
-  5 × 3



PU, PAPER

A5, 160 DOTTED PAGES

PEN LOOP



07



13

2681

A5 Notebook Tilburg

Elegant DIN A5 notebook with 160 dotted pages, bookmarks and a ballpoint pen loop, an insert and a smartphone compartment (width approx. 9 cm) on the outside of the cover. So everything is there and always ready to hand. We will print your logo on the outside of the cover.

✂ 21,3 × 14,5 × 1,5 cm

📄 S1

📏 6 × 6

CARDBOARD, PAPER 100 STICKY NOTES



3743

Marking Strip Book Huntsville

Marking strip book made of cardboard with five different coloured marking strips (20 sheets each). We print your logo on the outside of the cover.

✂ 8,1 × 0,3 × 5,9 cm
📄 T2
📏 4 × 2,5

CARDBOARD, PAPER 200 STICKY NOTES



8268

Adhesive note pad Burlington

Sticky notes booklet, with large (50 sheets), medium sticky notes (25 sheets), and five differently colored marking strips (25 per color). We print your logo on the cover.

✂ 10,5 × 8 × 1 cm
📄 T2
📏 5 × 3



CARDBOARD, PAPER 150 STICKY NOTES, 200 BLANK PAGES PEN INCLUDED, BLACK REFILL

8269

Adhesive note pad St. Louis

Eco-looking notepad with 200 pages, yellow sticky notes (25 sheets), five differently colored marking strips (25 strips in each color) and a ballpen. We print your logo on the cover.

✂ 12,3 × 13,8 × 1,6 cm
📄 T3
📏 5 × 3



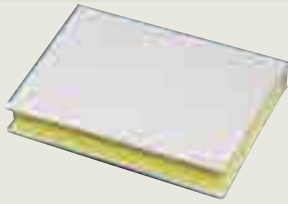

CARDBOARD,
PAPER

250 STICKY NOTES

1283

Adhesive notepad Allentown

Practical sticky note pad that includes 100 large + 25 smaller sticky notes, and 5 colored sticky note dispensers (25 sheets each.) We will print your logo on the cover.

✂ 8,5 × 10 × 2 cm

☒ T3

☑ 5 × 4



CARDBOARD,
PLASTIC, PAPER

630 STICKY NOTES

1608

Sticky note book Amarillo

Sticky note booklet, with yellow and pink note pads (each with approx. 90 sheets) and 5 different colored marking strips (approx. 90.) We will pad print your logo on the lid.

✂ 17 × 8,5 × 1,9 cm

☒ T3

☑ 5 × 4

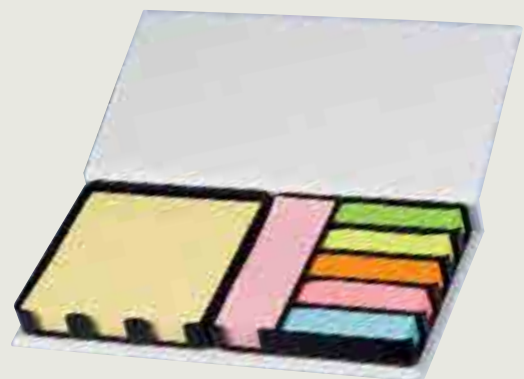

PAPER, 300D
CANVAS

A5, 160 LINED
PAGES

BOOKMARK,
ELASTIC CLOSURE



0829

A5 Notebook Bremen

A5 notebook with a classy 300D canvas polyester cover, black rubber closure, and bookmark. 160 lined pages. We print your logo on the cover.

✂ 14 × 21 × 1,3 cm

☒ TT1

☒ 7 × 7



03



04



05

PAPER, PU

A5, 160 SQUARED
PAGES

BOOKMARK,
PEN LOOP
ELASTIC CLOSURE



1445

A5 Notebook Bardolino

A5 notebook with 160 squared pages, PU fabric cover, bookmark, ballpen loop, and elastic rubber closure band. We print your logo on the white surface.

✂ 14,2 × 21 × 1,8 cm

☒ T3

☒ 5 × 3



ECO

PAPER

A5, 160 LINED PAGES

BOOKMARK,
ELASTIC CLOSURE,
PEN LOOP

RECYCLED MILK CARTON



3747

A5 Recycled milk carton notebook Izmir

A5 notebook made from recycled milk carton with 160 lined pages, bookmark, rubber closure band and ball pen loop. We print your logo on the cover front.

- ✂ 14 × 1,3 × 21,1 cm
- ✂ T3
- ✂ 5 × 3



ECO

PAPER

A6, 140 LINED PAGES

BOOKMARK,
ELASTIC CLOSURE,
PEN LOOP,
BLUE REFILL

RECYCLED MILK CARTON



3746

Recycled spiral notebook from milk carton Austin

Spiral notebook made of recycled milk carton with 140 lined pages, rubber closure band, ball pen loop and a cardboard ball pen with blue writing plastic refill. We print your logo on the cover front.

- ✂ 9 × 1,5 × 14,6 cm
- ✂ T3
- ✂ 5 × 3



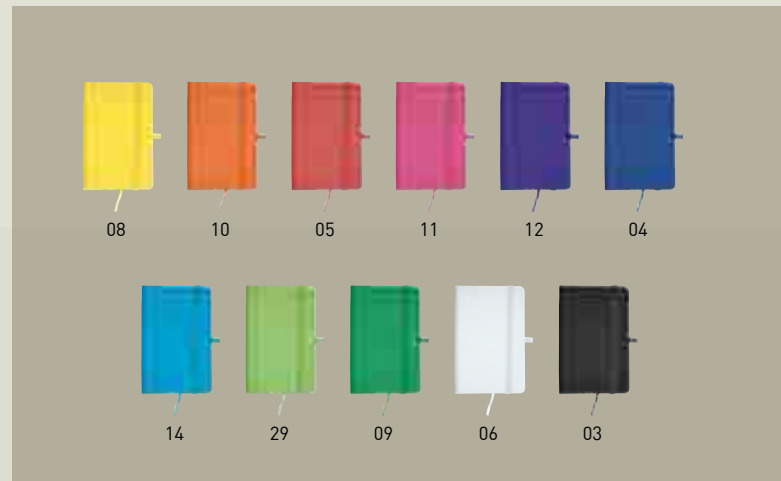
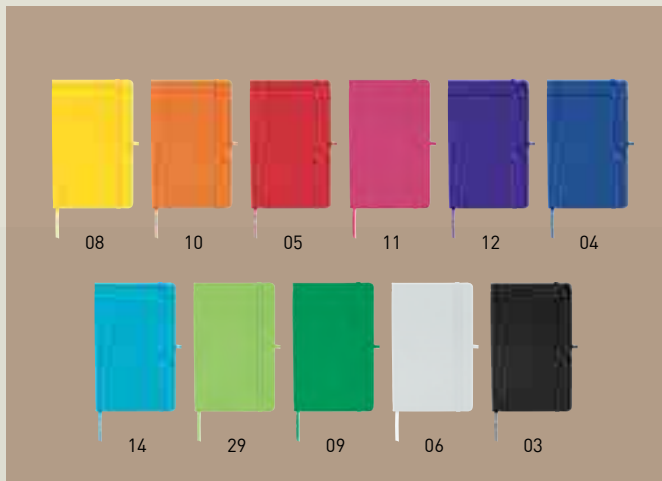

PAPER, PU
 A5, 160 BLANK PAGES
 PEN LOOP, BOOKMARK, ELASTIC CLOSURE

TOP PRICE

3121
A5 note book Kiel
 TOP PRICE! DIN A5 notebook in velvety PU cover with 160 neutral pages. We print your logo on the cover.
 ✂ 21 × 13,2 × 1,4 cm
 ☒ T2
 ☒ 5 × 3

PAPER, PU
 A6, 160 BLANK PAGES
 PEN LOOP, BOOKMARK, ELASTIC CLOSURE

TOP PRICE

1984
A6 note book Lübeck
 TOP PRICE! DIN A6 notebook in velvety-PU cover with 190 neutral pages. We print your logo on the cover.
 ✂ 9,3 × 14,4 × 1,5 cm
 ☒ T2
 ☒ 5 × 3



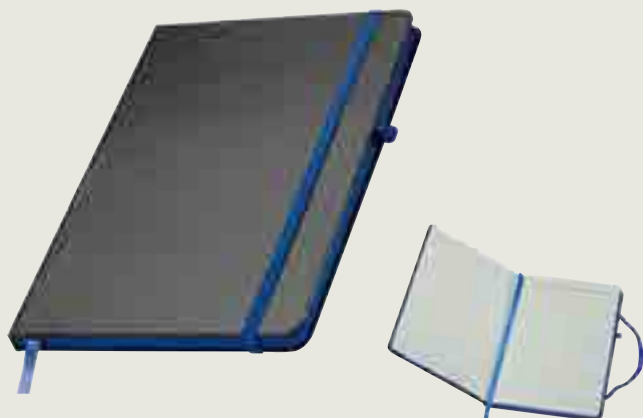

 PAPER, PU
 A5, 160 LINED PAGES
 PEN LOOP, BOOKMARK, ELASTIC CLOSURE



0379

A5 notebook Cuxhaven

DIN A5 notebook with PVC cover, pen loop, bookmarks, and lined pages (160.) We will print your logo on the cover.

 14,2 × 21 × 0,9 cm
 T3
 5 × 3

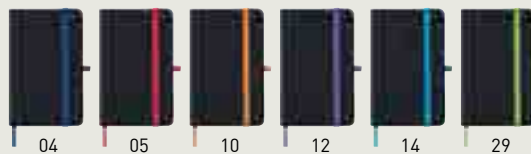

 PAPER, PU
 A6, 160 LINED PAGES
 PEN LOOP, BOOKMARK, ELASTIC CLOSURE



3411

Notebook Rostock

Notebook with black PU cover and 160 lined pages. Elegant look through colorful accents. We will print your logo on the cover.

 14 × 9 × 1,4 cm
 T3
 5 × 3

PAPER, PU

A6,
160 SQUARED PAGES



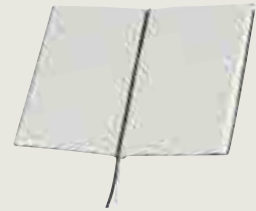

FLEXIBLE COVER,
2 BOOKMARKS



1438

A6 Notebook Elverum

A6 notebook with 160 squared pages, flexible soft PU cover, and bookmark. We print your logo on the front smooth surface.

 10,2 × 1,3 × 14,6 cm
 T3
 5 × 2

PAPER, PU

A5,
200 SQUARED PAGES





FLEXIBLE COVER,
2 BOOKMARKS



1439

A5 Notebook Dubai

A5 notebook with 200 squared pages, flexible soft PU cover, and bookmark. We print your logo on the front smooth surface.

 14,8 × 1,5 × 21,3 cm
 T3
 5 × 3

CARDBOARD,
PAPER, PU

A5, 160 LINED
PAGES





PEN LOOP, ELASTIC
CLOSURE,
4 POCKETS



0728

A5 notebook Perugia

A5 notebook in leather imitation, with 80 lined pages, 4 slide-in compartments and pen loop. We will print your logo on the cover.

 14,5 × 21 × 0,7 cm
 T3
 5 × 3



 POLYESTER, PAPER

 A4, 40 BLANK PAGES

 PEN LOOP

1011

Conference folder A4 Panama

Briefcase made of durable 600D polyester; with various compartments, 270° zipper, and a neutral writing pad (40 pages.) We print your logo on the Soft PU border.

 25,5 × 34 × 2,5 cm

 S1

 15 × 4





 PVC, PAPER



 A4, 40 LINED PAGES

 2x PEN LOOP, TABLET/SMARTPHONE HOLDER

0627

A4 conference folder Mondeville

A4 writing case made of durable fabric with pen loop, seven slip pockets, four elastic bands, a cell phone pocket, a tablet / smartphone holder and a lined writing pad (60 pages). We print the logo on the front of the folder.

-  24 × 33 × 1,5 cm
-  S1
-  12 × 12



 POLYESTER, PAPER



 A4, 40 LINED PAGES

 PEN LOOP, MAGNETIC CLOSURE, SMARTPHONE COMPARTMENT

0675

A4 conference folder Salerno

DIN A4 folder with various compartments and loops, mobile phone pocket, a writing pad (20 pages) and magnetic closure. We will transfer print your logo the front.

-  31 × 23,5 × 1,3 cm
-  TT1
-  15 × 10





 **BONDED LEATHER,
PAPER**

 **A4, 60 LINED
PAGES**

 **PEN LOOP,
TABLET/SMARTPHONE
HOLDER**

0625

A4 conference folder Milwaukee





A4 writing case with finest Bonded Leather (leather fiber fabric), various rubber loops and slip pockets, ring binder insert, writing pad (60 pages), tablet / smartphone holder, cell phone pocket, carry handle and zipper closure. Your logo will be laser engraved on the outside of the metal plate.

 27 x 36,5 x 6 cm

 L3

 4,5 x 1,5





-  POLYESTER,
PU, PAPER
-  MICRO-USB, USB-A, IOS
-  4.000 MAH
-  A5, 128 BLANK PAGES
-  PEN LOOP,
TABLET/SMARTPHONE
HOLDER,
CHARGE INDICATOR







0486

Notebook with powerbank

Powerbank folder in A5 format with integrated powerbank (4,000 mAh and charge indicator on the back), tablet or smartphone holder, various pockets and a removable notebook (128 unlined pages). We laser your logo on the front of the closure.

-  17,8 × 22,5 × 3,2 cm
-  L3
-  3,5 × 2





-  PU, PAPER
-  MICRO-USB, USB-A, IOS
-  5.000 MAH
-  A4, 40 LINED PAGES
-  PEN LOOP,
TABLET/SMARTPHONE
HOLDER,
CHARGE INDICATOR



0123

A4 folder

A4 folder made of bonded leather including a power bank (capacity 5.000 mAh), USB-cable, 8 pockets, cell-phone pocket, ball pen loop, tablet pocket and a note pad. We will print your logo onto the folder.

-  26,2 × 33,6 × 3,1 cm
-  T1
-  10 × 10



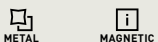

0723

Business card holder Cardiff

Business card holder made of metal with leatherette cover and magnetic closure. The logo is lasered onto the metal strip.

- ✂ 9,7 × 6,4 × 1,5 cm
- ☒ L2
- ☑ 5 × 0,8



2206

Metal business card holder Cornwall

Fancy matt metal business card holder in an individual box. The lid has the perfect surface for your logo, which will be engraved on the center.

- ✂ 9,4 × 5,8 × 0,7 cm
- ☒ L2
- ☑ 5 × 2



TOP PRICE

3419

Calculator Dubrovnik

TOP PRICE! Design calculator with 12 digits made of silver plastic. Your logo will be printed on the grey inlay.

- ✂ 16,5 × 12 × 2,1 cm
- ☒ T3
- ☑ 6 × 4





SUBLIMATION

Sublimation emblemization enables the transfer of high-quality and durable emblems, patterns, or images onto various promotional items' surfaces.

This process relies on the use of sublimation inks, which transition into a gas state under the influence of heat, embedding themselves deeply into the material of the objects. As a result, smooth and long-lasting emblems are created, characterized by excellent quality and resistance to wear.



1586

Cleaning cloth Bolton

Microfibre cloth suitable for cleaning glasses, glass surfaces or LCD screens. Your logo can be printed all over the cloth via sublimation.

- ✓ 15 × 15 cm
- ✗ SU
- ☒ 15 × 15



0478

Sublimation mousepad Malatya

A must-have on every desk and you with your logo always present. Mouse pad made of rubber with spandex surface. The mouse pad is fully printable in sublimation printing (CMYK), so even photos are easily convertible.

- ✓ 23,6 × 20 × 0,3 cm
- ✗ SU
- ☒ 19 × 23

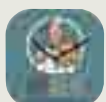

1996

Wall clock with all over clock face Bel Air

Design this wall clock the complete clock face according to your ideas. We print your layout on a film and stick this on the clock face. Please note that the movement and the hands are supplied unassembled to protect them from transport damage. Excluding a AA battery (order this right away, see last page or article 999300).

➤ 22,9 × 22,9 × 1,6 cm

⊗ ETN2

☰ 22,2 × 22

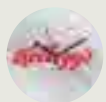
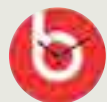

3499

Wall clock with allover printable dial Venice

Design the complete dial of your clock according to your wishes, we will make it possible full color print. Dials are delivered separate.

➤ ø 23 cm

⊗ ETN2

☰ ø 23

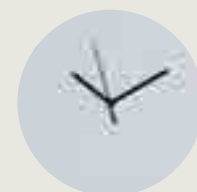



SLATE

3195

Slate wall clock Graz

Elegant wall clock made of slate (natural stone) with silver hands. This clock is an eye-catcher in every room! Your logo will be engraved onto the watch.

- ✂ ⌀ 25 × 3 cm
- ⊗ T4
- ☰ 5 × 3

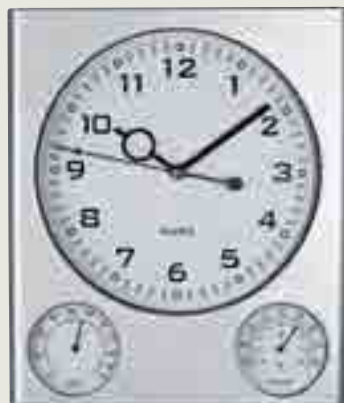

PLASTIC

THERMOMETER.
HYGROMETER

1213

Plastic wall clock Den Haag

Elegant wall clock with subtle white dial and matt silver surface; displays time, humidity, and temperature. We will print your logo between the hygro and thermometer.

- ✂ 27,3 × 3,5 × 32 cm
- ⊗ T4
- ☰ 5 × 4



PLASTIC

THERMOMETER.
HYGROMETER

3064

Wall clock Bagio

Wall clock in cool sports design. The clock has a thermometer and a hygrometer. We print your logo on the frame below the six. Excluding one AA battery (order it right away, see last page or article 999300).

- ✂ ⌀ 30 × 4 cm
- ⊗ T4
- ☰ 6 × 2,5



3738

Wall Clock Hampton

Wall clock made of bamboo. Excluding one AA battery (please order this at the same time, see last page or article 999300). Your logo will be laser engraved below the 12 o'clock display. Due to the natural bamboo grain, each item and each engraving is unique.

📏 $\varnothing 30 \times 1$ cm

📦 L3

📦 10 x 5





TIME



DATE



TEMPERATURE



2462

Desk clock North Charleston

Elegant desk clock with wooden coating, black display space and blue LED letters, showing time, date and temperature by turns. Your logo will be engraved onto the top.

- ✂ 6,2 × 6,4 × 6,3 cm
- 🔋 L3
- 📏 4 × 4



1030

Acrylic desk pen holder Madrid

Acrylic desk pen holder with silvered front; features clock, alarm, date, day of the week, and room temperature (C / F) and includes a button cell battery. We will print your logo below the multifunction display.

- ✂ 10,5 × 5,5 × 12,5 cm
- 🔋 T4
- 📏 4 × 2

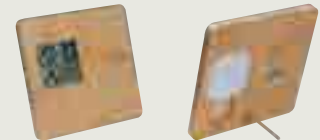

3194

Bamboo weather station Granada

Bamboo weather station / wireless charger with digital display showing temperature, humidity and time. Provides a stable stand. Your logo will be engraved on the front.

- ✂ 18 × 1,8 × 17 cm
- 🔋 L3
- 📏 5 × 5



INDUCTIVE CHARGING

Inductive charging is a charging technology that allows electrical devices to be charged without physically connecting them to a charger. The basis of inductive charging is the charging current created by an electromagnetic field. When we place the device on the stand, the stand creates an electromagnetic field that passes through the charging circuit in the device and charges it. The advantage of inductive charging is that it is easy to use, we do not need to use a separate charging cable, and it is usually faster than traditional charging methods.



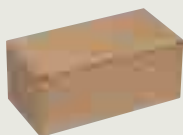

-  ECO
-  BAMBOO
-  MICRO-USB
-  USB-A
-  WIRELESS CHARGING
-  ALARM FUNCTION
-  THERMOMETER



2672

Desk clock Trondheim

Digital desk clock made of bamboo with LED display, wireless charging, alarm function and temperature display. Your logo will be lasered onto the bamboo coating. Due to the natural bamboo grain, each item and each engraving is unique.

-  16 x 7,5 x 4 cm
-  L3
-  6 x 4



3595

Desk organizer Lublin

Bamboo desk organizer with 10 watt induction charging station, storage compartment, pen holder and charging cable (notepad is not included). Your logo will be engraved on the organizer. The natural bamboo grain makes each item and engraving unique.

- ✂ 24,5 × 13 × 9 cm
- ☒ L3
- ☒ 4 × 6



2695

Bamboo smartphone holder San Sebastián

A piece of nature for the desk. Beautiful smartphone holder made of bamboo. In addition to your smartphone, your logo is always in view. We laser this in the middle of the holder.

- ✂ 8 × 6 × 2 cm
- ☒ L2
- ☒ 5 × 2



2377

Pen holder Fredericton

Pen quiver with cell phone holder made of bamboo and a tunnel to pass the charging cable, making it no longer visible. Your logo will be laser engraved on the quiver. The natural bamboo grain makes each item and engraving unique.

- ✂ 7,9 × 10,5 × 12 cm
- ☒ L3
- ☒ 5 × 3



CORK,
BAMBOO

WIRELESS
CHARGING

USB-TYPE-C, USB-A

3752

Desk organiser with charging station Lancaster

Stylish desk organiser made of cork with induction charging station (10 watts) made of bamboo and USB-C charging cable. An eye-catcher on any desk. We will print your logo to the induction charging panel by means of laser engraving.

✂ 26,7 × 13,9 × 1,8 cm

📦 L3

📦 4 × 2



ALUMINIUM,
PLASTIC

2475

Adjustable Phone Holder Setúbal

Phone holder with adjustable head, non-slip bottom and surface. Your logo will be engraved on the base.

✂ 15,7 × ø 9,8 cm

📦 L2

📦 4 × 3





3191

Wireless charger Galway

Bamboo wireless charger and smartphone holder. Input DCSV = 2A, wireless output 10W, including charging cable. Your logo will be engraved on the bottom of the charger.

✂ 7,2 × 8 × 12 cm

☒ L3

☒ 5 × 5



ECO



BAMBOO



MICRO-USB,
USB-A



WIRELESS
CHARGING



1200 MAH



3605

Induction loudspeaker Nuremberg

Bamboo speaker with 1,200 mAh battery, charging cable and induction charging function at the front. For all Qi-enabled smartphones. Your logo will be engraved on the speaker.

➤ 14,5 × 9 × 7,4 cm

⊠ L3

⊞ 6 × 3

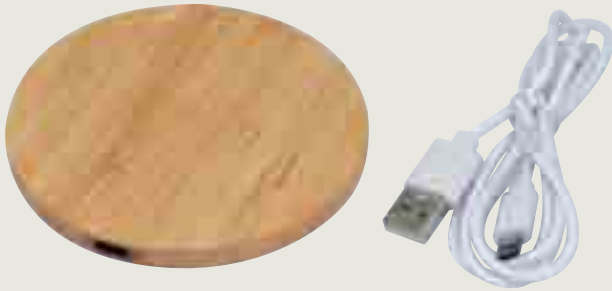

2457

Inductive charger Mons

Round bamboo wireless charger with charging cable, suitable for all Qi-enabled smart phones. We will place your logo on the charger.

- ø 9 × 0,8 cm
- ⊞ L3
- ⊞ ø 5



3190

Wireless charger and powerbank Milan

Wireless charger and powerbank with 8,000 mAh, 5 Watt, USB and USB-C input, including a bamboo charging cable. The logo will be engraved on the charger.

- 13,6 × 6,8 × 1,1 cm
- ⊞ L2
- ⊞ 5 × 5



ECO



BAMBOO



USB TYPE-C,
USB-A



10 W WIRELESS
CHARGING



3658

Charging station Nassau

Slim plastic charging station with bamboo surface and two induction charging points for smartphones, including a charging cable. Your logo will be engraved on the station.

✂ 15,5 × 6,1 × 1 cm

☒ L3

☒ 5 × 3



PLASTIC



MICRO-USB,
USB-A



5W WIRELESS
CHARGING



0736

Inductive charger

Charge your device easily without the need of cables, by simply placing your smartphone over the induction charger. This item is particularly suitable for the current Samsung and Apple smartphones starting from iPhone 8. We will print your logo directly on the charger.

- ✂ $\varnothing 7 \times 0,9$ cm
- ⊗ T3
- ☒ $\varnothing 4,5$



PLASTIC



USB TYPE-C, USB-A



5W WIRELESS
CHARGING



3598

Wireless charger Lincoln

Plastic wireless charger with 2 USB ports, charging cable included. Charges all Qi-enabled smartphones. Your logo will be printed on the device.

- ✂ $9 \times 9 \times 0,9$ cm
- ⊗ T3
- ☒ 4×4



PLASTIC



MICRO-USB,
USB-A



5W WIRELESS
CHARGING



06



03



0905

Inductive charger Crawley

Plastic induction charger, charge your smartphone with cordless technology. The wireless charger also works as a stand for your smartphone. We will print your logo on the front.

- ✂ $9,5 \times 5,5 \times 6,5$ cm
- ⊗ T4
- ☒ 7×4



ABS, PLASTIC

LED, COLOR
CHANGING

2638

Humidifier Nucia

Aroma humidifier with color-changing LED light made of plastic with a wood look. The humidifier has a capacity of approx. 130 ml and can be enriched with essential oils. The humidifier is operated with the included USB cable. We will print your logo on the humidifier.

- ✂ ø 9 × 8,9 cm
- ⊗ T3
- ☒ 3 × 1,5



PLASTIC

MICRO-USB,
USB-A

3573

Table lamp Montes Claros

Plastic table lamp with touch function, infinitely dimmable and rechargeable battery. Your logo will be attached to the lampshade.

- ✂ ø 10,5 × 25,7 cm
- ⊗ T4
- ☒ 4 × 3



ECO



BAMBOO



MICRO-USB,
USB-A



8000 MAH

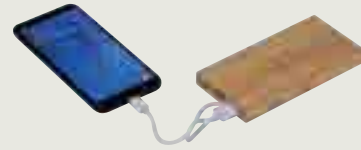

1473

Bamboo power bank Katowice

8.000 mAh Power bank in bamboo case, includes charging cable. Your logo will be engraved on the case.

✂ 13,8 × 6,9 × 1,4 cm

☒ L3

☒ 5 × 3



ECO



BAMBOO, PLASTIC



MICRO-USB,
USB-A



SOLAR
POWER



8000 MAH

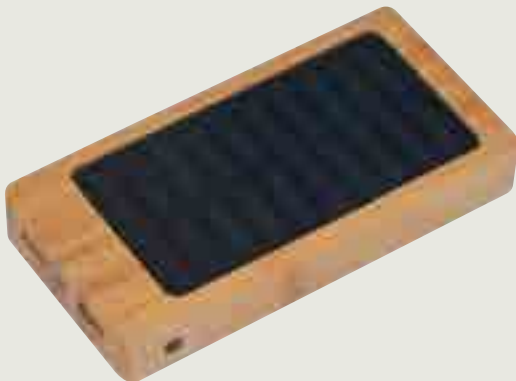

2563

Bamboo Powerbank Bakersfield

Powerbank in bamboo case with 8,000 mAh power and a solar panel including charging cable, flexibility even without power outlet. The logo will be engraved on the powerbank.

✂ 14,2 × 7,1 × 2 cm

☒ L2

☒ 2 × 1



SOLAR POWER

Solar power banks are equipped with photovoltaic panels that convert solar energy into electricity. The battery stores the energy, which can then be used to charge devices when needed.

Solar power banks are small and easily portable, making them ideal for travel, hiking, or anywhere that access to an electrical grid is not available. With a solar power bank, you can prevent your devices from running out of power and ensure that you always stay connected.



3559

Solar powerbank

Solar metal powerbank with a capacity of 4.000 mAh including a charging cable. You can now charge your phone or tablet anytime/anywhere without a plug socket. We will engrave your logo below the solar field.

✂ 12,5 × 7,8 × 1,4 cm

🔌 L3

📦 6 × 1



0638

4000 mAh Powerbank Chieti

Powerbank with suction cups, 2in1 charging cable (Android + iOS) and 4000 mAh power capacity, fix it directly to your smartphone. We will engrave your logo on the front.

✂ 12,3 × 5,6 × 1,3 cm

⚙ L2

📦 4 × 3



05

07

0825

Power bank Lieto

Aluminium power bank with 4.000 mAh charging capacity, charge indicator, multiplug charging cable (lightning, USB Type C, and Micro-USB.) Your logo will be engraved.

✂ 11 × 6,7 × 1 cm

⚙ L3

📦 5 × 3



03



04



05



07

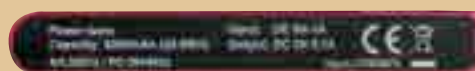

ALUMINIUM



MICRO-USB,
USB-A



8000 MAH



2612

Powerbank 8.000 mAh Wolfsberg

Power bank made of aluminum with charge level indicator and a capacity of 8,000 mAh. Including micro USB charging cable. We engrave your logo on the power bank.

✂ 15,2 × 7,5 × 1 cm

📦 L3

📦 5 × 5

PLASTIC USB-A, MICRO-USB 10 000 MAH



1184

Power bank 10.000 mAh Kilis

Powerbank with 10.000 mAh capacity, charging cable and display. Due to the two USB ports, 2 smartphones/tablets can be charged simultaneously. We will print your logo on the smooth surface.

✂ 8,8 × 6 × 2,2 cm
☒ T4
☑ 5 × 3



PLASTIC USB-A, MICRO-USB 10 000 MAH CHARGE INDICATOR, LED



0518

power bank 10.000 mAh

Power bank with a capacity of 10.000 mAh, USB charging cable and digital operation display to show the remaining power. You can recharge your smartphone several times with this plastic power bank. We will print your logo on the top.

✂ 14 × 6,2 × 2,2 cm
☒ T4
☑ 5 × 3





3514

Power bank Kingsville

This easy-to-use, external metal battery with capacity of 4000 mAh pulls every smartphone out of trouble. The USB cable included in the package can be recharged from a PC.

✂ 12 × 6,7 × 1 cm

📦 T3

📦 5 × 2



1498

Power bank Cracow

Power bank with 20.000 mAh capacity, digital charging display and charging cable included. The 2 USB ports make it easy to charge 2 devices several times at the same time. Your logo will be printed on the power bank.

✂ 14,4 × 6,5 × 2,5 cm

📦 T4

📦 4 × 3





PLASTIC



USB-A, MICRO-USB



2 200 MAH



CMYK ALLOVER
PRINT

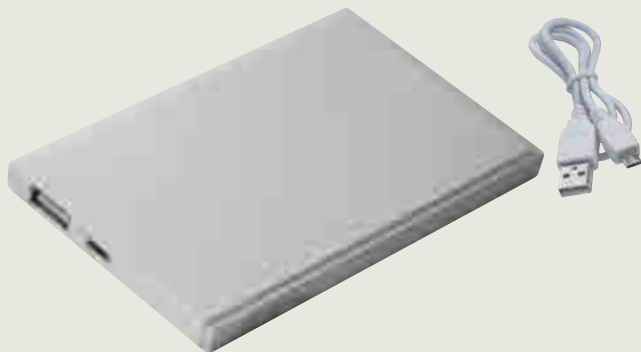

0346

Powerbank 2200 mAh with USB port in a box

Powerbank with a capacity of 2,200 mAh and charge indicator, incl. USB charging cable. So your smartphone can be charged on the go. We print your logo in UV printing (CMYK) directly on the powerbank.

- ✂ 11,9 × 6,7 × 0,9 cm
- ⊠ DC2
- ☰ 10,5 × 6



PLASTIC



USB-A,
MICRO-USB



2 200 MAH



0081

Travel set - Powerbank, EU Plug, USB Charger

Travel set consisting of a USB charger for the car, powerbank (2.200 mAh), EU plug and a USB cable, packed in a case. We will print your logo onto the case.

- ✂ 11,7 × 8,1 × 3,8 cm
- ⊠ T3
- ☰ 4 × 2





0343

Powerbank 2200 mAh with USB port in a box

Powerbank incl. USB charging cable with a power of 2,200 mAh, so your smartphone can be charged on the go. We print your logo directly on the powerbank.

- ✂ 9,2 x 2,5 x 2,5 cm
- 🔧 T3
- 📦 5 x 1,5

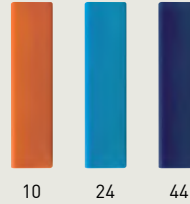

3029

Metal power bank Port Hope

TOP PRICE! Powerbank (2.200 mAh) made of metal incl. USB charging cable. You can use all standard smartphone cables to charge this powerbank. We will put your logo on one side by laser engraving.

- ✂ 9,5 x 2,2 x 2,1 cm
- 🔧 L2
- 📦 5 x 1,2







A4, 40 LINED
PAGES

PU, PAPER

USB-A, 2 IN 1
MICRO-USB+iOS

5 000 MAH

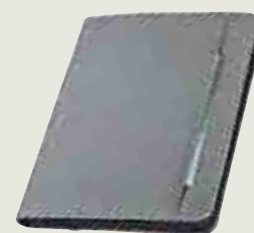

CHARGE INDICATOR,
PEN LOOP, TABLET/
SMARTPHONE
HOLDER



0123

A4 folder

A4 folder made of bonded leather including a power bank (capacity 5.000 mAH), USB-cable, 8 pockets, cell-phone pocket, ball pen loop, tablet pocket and a note pad. We will print your logo onto the folder.

 26,2 × 33,6 × 3,1 cm

 TT1

 10 × 10



A5, 128 BLANK PAGES

POLYESTER, PU, PAPER

USB-A, 2 IN 1 MICRO-USB+IOS

4 000 MAH

CHARGE INDICATOR, PEN LOOP, TABLET/SMARTPHONE HOLDER



0486

Notebook with powerbank

Powerbank folder in A5 format with integrated powerbank (4,000 mAh and charge indicator on the back), tablet or smartphone holder, various pockets and a removable notebook (128 unlined pages). We laser your logo on the front of the closure.

✂ 17,8 × 22,5 × 3,2 cm

📏 L3

📏 3,5 × 2



PU

USB-A, MICRO-USB, USB TYPE-C, IOS

4 000 MAH

CHARGE INDICATOR, PEN LOOP

0122

Document folder

Document folder made of bonded leather including a power bank (4.000 mAh capacity), USB-cable, 8 pockets, cell-phone pocket, ball pen loop and cell phone strap. We will print your logo onto the folder.

✂ 15 × 24,5 × 2,7 cm

📏 TT1

📏 6 × 5





PLASTIC

USB TYPE-C,
USB-A



2516

Travel Set Chiny

Travel Set consisting of an adapter charger for the car and a charger with EU power plug. Both have a USB and a Type-C connector and are packed in a lockable case. The logo is placed on the case.

✂ 10,5 × 5,5 × 4,7 cm
 ⚙ T3
 📦 5 × 2



PLASTIC, METAL

LED, LIGHTING



04

05

10

12

0928

USB charging adapter KFZ Fruit

Stylish charging adapter for the 12V car socket with two slots for fast or regular charging, the color ring lights while charging. We print your logo above the ring.

✂ 7 × 2,7 × 3,1 cm
 ⚙ T2
 📦 1,8 × 0,8



ABS,

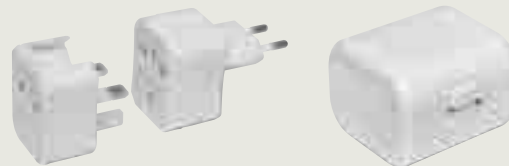

0394

Travel adapter

Wherever you travel to - from now on - you have always the needed adapter with you (US, UK, AUS, EU). Your logo will be printed onto the box.

✂ 6,2 × 5,9 × 4,6 cm
 ⚙ T3
 📦 4 × 2,5



PLASTIC



OVERCHARGE PRO-
TECTION, RECHARGES
STANDARD BATTERIES



7913

Battery charger Thunder Bay

This battery charger is a real innovation. You can charge and reuse up to 4 alkaline batteries (AA / AAA Alkaline) or even NiMH batteries within two hours. Includes a power plug. We print your logo on the silver surface.

✂ 12,5 × 6,8 × 2,6 cm

⊠ T4

⊠ 3,5 × 2,5



PLASTIC



WORLDWIDE ADAPTER SET

2097

Travel Adapter Antwerp

Travel Adapter for Europe, USA, UK and Australia. Featuring 2 USB outputs with 2.100 mA. Your Logo will be printed on one side of the adapter.

✂ 9 × 3,5 × 10,5 cm

⊠ T4

⊠ 4 × 2,5





PLASTIC



CREDIT CARD SIZE,
MAGNIFIES X3



1998

Credit card sized reading lens Posen

This small reading lens can be used everywhere and is very practical because of its size. It is a perfect mailing item and provides plenty of space for your logo. Comes in a poly bag. We will print your logo on the space below the lens.

✂ 8,6 × 5,5 cm

🌀 T2

📏 5 × 1,5



PLASTIC



LED LIGHT,
MAGNIFIES X3



2238

Magnifying glass with LED Gloucester

Magnifier made of plastic with triple magnification and a built-in LED. We print your logo on the handle. The scope of delivery already includes a button cell.

✂ 14,8 × 6,4 × 1,1 cm

🌀 T3

📏 4 × 1,5



PLASTIC



MICRO-USB, USB-A



03

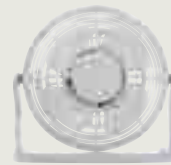

06

0846

Table fan Bali

Quiet, swiveling USB table fan with a lot of power. We print your logo on the front (just 1C possible).

✂ 14,5 × 9,5 × 14 cm

🌀 T4

📏 ø 4



0967

Mobile phone holder Red Rose

Plastic cell phone holder with integrated shopping cart chip to stick on the cell phone. We print your logo on the cell phone holder.

- ✂ 3,4 × 0,7 cm
- ☒ T2
- ☑ 2,2 × 1,5

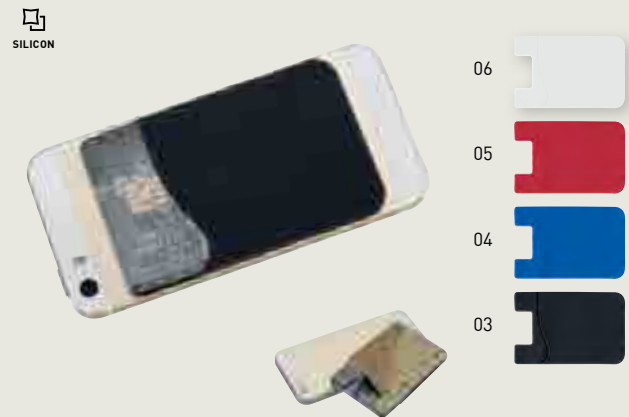

2864

Smart phone bag Bordeaux

A trendy companion. Mobile phone bag with adhesive film on the back for easy-attachment to your smartphone, with space for cards and more. We print your logo in the middle of the bag.

- ✂ 5,6 × 8,5 × 0,2 cm
- ☒ T4
- ☑ 4 × 4



SILICON, PLASTIC, METAL
 USB-A, MICRO-USB, USB TYPE-C, IOS

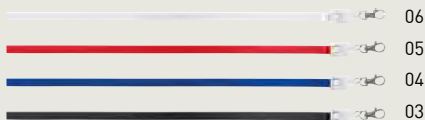

0639

Lanyard with universal charging cable Reno

Plastic lanyard with universal charging cable (for Android and IOS) and small snap hook. Your logo will be printed on the lanyard (only 1 colour print possible).

- ✂ 98 × 1 cm
- ☒ S1
- ☑ 20 × 0,8



SILICON
 MOBILE HOLDER

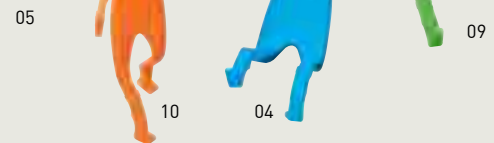

8620

Mobile phone holder Lodsch

Tidy! With this flexi-man you can tuck your phone away while charging. We will print your logo in the middle. Printing is only possible in one color in white.

- ✂ 15,2 × 0,5 × 20,6 cm
- ☒ T4
- ☑ 3 × 0,8



**SCREEN
PROTECTION
AGAINST**

- GLASS BREAKAGE
- GLASS SCRATCHES
- HARDER BLOWS



SCAN AND SAFE
PRODUCT VIDEO

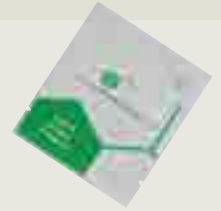
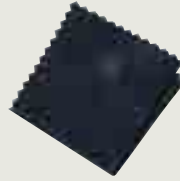

0834

Screen protector Los Andes

Liquid screen protector for smartphones, smartwatches, and tablets. The liquid glass seal makes your display a lot more resistant than a protective film and is completely invisible. We will print your logo on a label on the box.

- ✂ 9 × 14,8 × 0,2 cm
- ☒ ETN1
- ☒ 4 × 1



POLYESTER, ACRYL TOUCH FUNCTION



8765

Acrylic gloves Cary

Using your smartphone while keeping your hands warm during winter - this is no problem with these touch screen gloves made of soft acryl with conductive tips on the thumb and index fingers. We will print your logo on a glove.

- ✂ 22 × 10,5 × 2 cm
- ☒ TT2
- ☒ 5 × 5



ECO



CARDBOARD



0356

Virtual Reality glasses made of cardboard

Virtual reality glasses; simply install the cardboard app on your smartphone, then insert the smartphone into the slot, and now you can explore the virtual world! We print your logo on one side.

- ✂ 14,3 × 9 × 6 cm
- ☒ T4
- ☒ 5 × 3



ECO
BAMBOO, PLASTIC
USB-A, USB TYPE-C



3754

USB Hub Kuala Lumpur

USB hub made of bamboo with one USB and one USB-C plug, as well as two USB and one USB-C input. Your logo will be laser engraved on the hub.

✂ 8 × 3,7 × 1 cm
⊞ L2
☰ 3 × 2



ECO
BAMBOO, PLASTIC
USB-A, MICRO-USB, USB TYPE-C, iOS
EXPANDABLE TO 80 CM



3199

Bamboo charging cable Groningen

Extendable charging cable in a plastic housing with a bamboo plate, USB, 2 C-Type and an iOS adapter. Your logo will be printed onto the bamboo part.

✂ 12,2 × 4,2 × 1,6 cm
⊞ L2
☰ ø 3



ECO
BAMBOO, PLASTIC
USB-A, MICRO-USB, USB TYPE-C, iOS
EXPANDABLE TO 80 CM



3675

Charging cable Strasbourg

Charging cable with USB, C-Type, Mini USB and iOS connection. Made of plastic with bamboo decoration. Your logo will be printed on the bamboo part.

✂ 25 × 5 × 2 cm
⊞ L2
☰ 3,5 × 3,5

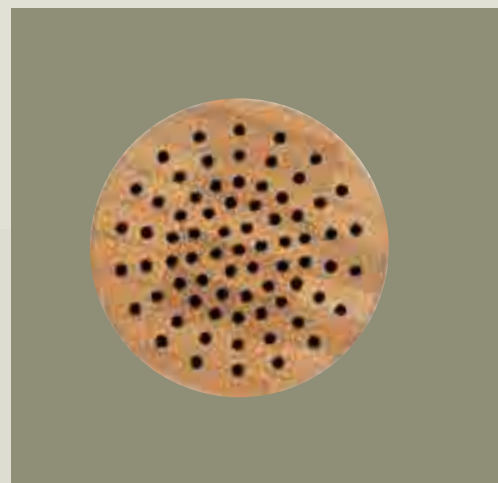

ECO



BAMBOO



MICRO-USB



USB-A



BLUETOOTH



BATTERY
300 mAh, 3W



0901

Bluetooth speaker Fleadwood

Stylish Bluetooth speaker in bamboo housing incl. USB charging cable. Other features: Micro SD card slot to play MP3 files, AUX connection. Battery life approx. 40-70 minutes. We laser your logo on the case.

📏 ø 5,8 × 5 cm

📏 L3

📏 3 × 2



BLUETOOTH

Bluetooth audio devices allow wireless transmission of audio data from a source device (such as a smartphone, tablet, or computer) to a receiver device (such as a speaker or headphones). Using Bluetooth technology, the desired devices are able to connect to each other without the need for physical connectivity.

As a result, Bluetooth audio devices are very convenient and portable, making them very popular for listening to music, transferring data between devices, or even in home theater systems.



ECO



BAMBOO,
ABS



MICRO-USB,
USB-A



BLUETOOTH



300 MAH, 2 HOURS
CHARGING



COLOR CHANGING,
RANGE UP TO 10 M



3208

Bluetooth speaker Haarlem

Bluetooth 5.0 speaker made of ABS and bamboo with color-changing LED light, 300 mAh battery, charging time 2 hours and a range of up to 10 meters. Your logo will be placed onto the speaker.

📏 $\varnothing 6 \times 10,5$ cm

📦 L3

📦 4 x 4



ABS, RUBBER



MICRO-USB, USB-A



BLUETOOTH



3W, battery
300mAh



40-70 MINUTES
WORK



0897

Bluetooth speaker Iceland

Chic, handy Bluetooth speaker with rubberized housing. Incl. USB charging cable and AUX connector. Battery life approx. 40-70 minutes. We laser your logo on the housing.

✂ 7 × 7 × 3,8 cm

🔊 L3

📏 3 × 0,5



ABS



MICRO-USB, USB-A,
2x3.5 mm JACK



BLUETOOTH



180-240
MINUTES WORK,
25 W, 1.200 MAH



0942

Bluetooth speaker Music man









Large splash-proof Bluetooth stereo speaker with high fidelity sound, extra strong bass effect, cell phone holder, hands-free, battery life about 3-4 hours, Bluetooth range about 10m, charging time about 5-6 hours. We laser your logo on the top of the front surface.

✂ 18 × 12 × 10,2 cm

🔊 L3

📏 4 × 1,5





- 
 ECO
- 
 BAMBOO
- 
 RECYCLED
 PET
- 
 USB TYPE-C,
 USB-A
- 
 BLUETOOTH
- 
 BATTERY
 1.200 MAH
- 
 60-120
 MINUTES WORK
- 
 WIRELESS
 CHARGING 15W



3815

RPET Loudspeaker with wireless charger Piacenza

Bluetooth speaker (5 Watt, battery: 1200 mAh) made of recycled PET with induction charging surface (15 Watt) made of bamboo incl. USB-C charging cable (ca. 50 cm). Your logo will be laser engraved on the bamboo surface.

-  ø 10,2 × 8,2 cm
-  L3
-  ø 5



PLASTIC



MICRO-USB, USB-A



BLUETOOTH



3W, BATTERY 200 MAH



30-60 MINUTES WORK, LED



0925

Bluetooth speaker Taifun

Trendy Bluetooth speaker including USB charging cable and a battery life of 30 - 60 minutes. Additional features: Top and bottom light effects, Micro SD card slot, Micro USB and USB port. We print your logo on the case.

➤ ø 5,8 × 5,1 cm

🔊 T3

📀 3 × 2



03



04



05



06



07



METAL, RUBBER



MICRO-USB, USB-A



BLUETOOTH



3W, BATTERY 520 MAH



50-90 MINUTES WORK, RADIO



03



07

3369

Wireless bluetooth speaker

Mini bluetooth speaker with USB connection for charging and radio. Connect your smartphone or tablet wirelessly to the speaker, and enjoy a perfect sound. You can listen to your favourite music in good sound quality with an operating distance of up to 10 meters and a runtime of up to 5 hours. We will laser engrave your logo on the speaker.

➤ ø 6 × 5,1 cm

🔊 L3

📀 3 × 2



0589

Bluetooth speaker Alicante

Bluetooth speaker with many features: FM radio, AUX port, MP3 playback via Micro SD cards or USB slot, includes USB charging cable with 3.5 mm jack plug as well as a detachable carrying strap and a battery life of 2 hours. Your logo will be printed on the case.

✂ \varnothing 12,5 x 25 cm

☒ T4

☒ 4 x 2



0588

Bluetooth speaker Kingswood

Bluetooth speaker with anti-slip cell phone pad and a battery life of 70 - 90 minutes. Other features: Hands-free speakerphone, FM radio, Micro SD card slot, AUX port, Bluetooth range approx. 15 meters. Incl. USB charging cable and 3.5 mm jack plug cable. We print your logo on the case.

✂ \varnothing 8 x 6,3 cm

☒ T4

☒ 2,5 x 1,2







-  ECO
-  BAMBOO, PLASTIC
-  MICRO-USB, USB-A
-  BLUETOOTH
-  300 MAH
-  180 MINUTES WORK



2579

Bluetooth Headphones Barcelona

Ergonomic in-ear Bluetooth 5.0 headphones with charging indicator in a USB charging station that also serves as packaging. Radio range up to 10 metres, charging time approx. 1 hour, runtime 2-3 hours and 300 mAh battery. Your logo will be engraved on the charging station.

-  7,5 × 4,7 × 3,2 cm
-  L2
-  3 × 2



-  PLASTIC, SILICON
-  MICRO-USB, USB-A
-  BLUETOOTH
-  35 MAH, 60 MINUTESS CHARGE
-  120-180 MINUTES WORK



1462

In-ear headphones Warsaw

Ergonomic in-ear Bluetooth headset with USB charging cable and charging cradle, which also functions as case. Running time 2-3 hours, charging time approx. 1 hour, 35mAh battery. Your logo will be printed on the case.

-  9 × 4 × 3 cm
-  DC1
-  5 × 1,5

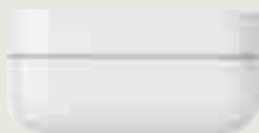

ECO



PLASTIC



USB TYPE-C,
USB-A



SOLAR POWER



BLUETOOTH



35 MAH, 60 MINUTES
CHARGE



3591

Bluetooth headphones Ontario

In-ear Bluetooth headphones with charging indicator and charging station. This can be charged either via the solar field in the lid or via the charging cable (included). Battery: 35mAh, runtime: 2-3 hours, charging time with cable: approx. 1 hour, charging time with solar field: approx. 4 hours. Your logo will be placed on the bottom of the box.

✂ 5,1 × 5,2 × 2,5 cm

☒ T3

☒ 3 × 3



PLASTIC



MICRO-USB,
USB-A



BLUETOOTH



180 MINUTES WORK,
60 MINUTES CHARGE



0471

Bluetooth earphones

Bluetooth earphones with volume regulation, they come in a zipper pouch, and with a USB charging cable. Your logo will be printed onto the pouch.

- ✂ 8,8 × 3,9 cm
- ☒ T3
- ☒ ø 3,5



PLASTIC



3.5 mm JACK



MOBILE STAND



1549

Mobile phone stand Noise

A box with function, includes earphones and earplugs. We print your logo on the box.

- ✂ 5,8 × 6,5 × 2,7 cm
- ☒ T3
- ☒ 5 × 2



PLASTIC



MICRO-USB,
USB-A



BLUETOOTH



180 MINUTES WORK,
60 MINUTES CHARGE



0574

Bluetooth earphones Antalya

Plastic bluetooth headset with hands-free and volume control, USB charging cable included. Your logo will be printed on the volume control.

- ✂ 67 × 1 cm
- ☒ T3
- ☒ 3 × 0,5





PLASTIC



MICRO-USB,
USB-A



BLUETOOTH



0822

Bluetooth headset Asti

Bluetooth headset with volume control and USB charging cable in a plastic case with hanging loop. We will print your logo on the case.

- $\varnothing 3 \times 9,5$ cm
- ☒ T3
- ☒ 2,5 x 1,5



PLASTIC



3.5 mm JACK



CABLE LENGTH
1 METER



2316

Headset with surround sound Dunfermline

Headset with surround sound, microphone and volume control. With the integrated noise cancelling you won't hear any background noise. Your logo will be printed on one earcup.

- 18 x 8,2 x 20 cm
- ☒ T4
- ☒ 3,5 x 0,8



METAL



USB-A



8 GB, 16 GB



1666

USB stick Suzano 8 GB

Metal USB flash drive Twister 3.0 with magnetic closing mechanism. Your logo will be lasered on the clip. For deliveries within Germany GEMA fees of 0,24€/pc. will be charged.

- ✂ 5,2 × 1,7 × 0,9 cm
- ⊗ L2
- ☒ 1,2 × 2,7



METAL



USB-A



8 GB, 16 GB



1653

USB-Stick Twister 16 GB

USB flash drive Twister 2.0 made of metal with magnetic closing mechanism. Your logo will be lasered on the protective cap. For deliveries within Germany, a batch fee of 0,24€/pc. will be charged.

- ✂ 5,2 × 1,7 × 0,9 cm
- ⊗ L2
- ☒ 1,2 × 2,7



METAL



USB-A



4 GB, 8 GB



8734

USB Card 4 GB

USB card made of metal with fold-out connector. The large area of metal is perfect for laser engraving. GEMA fees of € 0.24/piece apply for deliveries within Germany.

- ✂ 8,5 × 5,4 × 0,3 cm
- ⊗ L2
- ☒ 4 × 4



PLASTIC



USB-A



4 GB, 8 GB



0336

USB Card Slough 8 GB

USB card. Thanks to its flat shape it can be easily stowed anywhere. The large white area is perfect for digital print. Deliveries within Germany are subject to GEMA fees.

- ✂ 8,3 × 5,2 × 0,2 cm
- ⊗ DC1
- ☒ 8,3 × 5,2



METAL

USB-A

4 GB, 8 GB



0991

USB stick Landen 8 GB

USB flash drive made of metal. Your logo will be engraved on the metal surface. For deliveries within Germany, a community fee of 0,24€/pc. will be charged.

📏 3,9 × 1,2 × 0,5 cm
 📏 L2
 📏 0,8 × 2

METAL

USB-A

4 GB, 8 GB



0992

USB stick Las Cruces 8 GB

Metal USB flash drive with carabiner. Your logo will be engraved on the metal surface. For deliveries within Germany Gemabühren in the amount of 0,24€ / pce. will be charged.

📏 5,1 × 1,6 × 0,5 cm
 📏 L2
 📏 0,7 × 1,5

PU, METAL

USB-A

8 GB



8731

USB stick Leuven

USB flash drive with a storage capacity of 8GB in a leather case. Your logo will be lasered on the leather. For deliveries within Germany GEMA fees of € 0,24/piece apply.

📏 9 × 2,6 × 1,7 cm
 📏 L2
 📏 2,5 × 0,5



METAL

USB-A

4 GB, 8 GB

1493

USB Stick Spa 8GB

Metal USB stick with 8 GB storage capacity. Your logo will be engraved on the metal surface. Deliveries within Germany are subject to GEMA fees.

📏 4,5 × 1,7 × 0,4 cm
 📏 L2
 📏 2 × 0,8

MAPLE, METAL

USB-A

4 GB, 8 GB



0876

USB stick Lessines 4 GB

USB flash drive made of light wood (maple) and metal clip. We laser your logo on the metal clip. For deliveries within Germany GEMA fees of € 0,24/ piece apply.

✂ 5,7 × 2 × 1 cm
⊗ L2
☞ 1,2 × 2,7

BAMBOO, METAL

USB-A

4 GB, 8 GB



0877

USB-Stick Suruç 4 GB

Bamboo cover USB stick. Your logo will be engraved on the clip. Deliveries within Germany are subject to GEMA fees.

✂ 5,7 × 2 × 1 cm
⊗ L2
☞ 1,2 × 2,7

PLASTIC, METAL

MICRO-USB, USB-A

32 GB



0881

USB Ssick Twist

USB Flash Drive 3.0 with one USB Type A and one USB Type B port and 32GB storage capacity. Your logo will be lasered on the clip. GEMA fees of € 0.24 apply for deliveries within Germany.

✂ 7 × 1,9 × 1,1 cm
⊗ L2
☞ 2,7 × 1,2

WALNUT, METAL

USB-A

4 GB, 8 GB



0878

USB Stick League City 4 GB

USB flash drive made of dark wood (walnut) and metal clip. We laser your logo on the metal clip. For deliveries within Germany GEMA fees of € 0,24/ piece apply.

✂ 5,7 × 2 × 1 cm
⊗ L2
☞ 1,2 × 2,7



SHELL

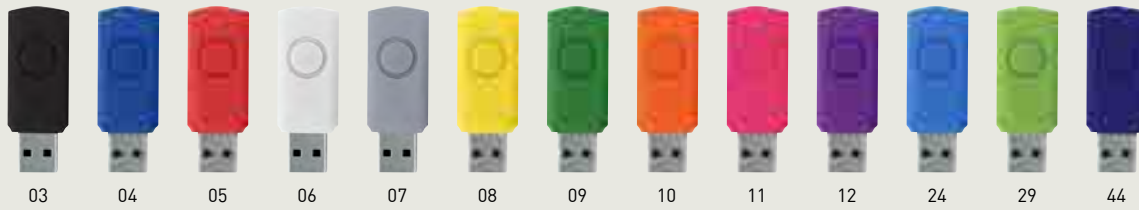

BODY



LANYARD



CAPACITY



BOX



LABELING

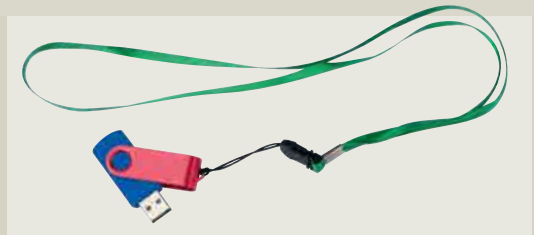

8726

USB stick Liège 4GB

Design your own custom USB flash drive. Choose the color of the body, the clip and the size of the memory. The USB sticks are available with laser engraving, printing or doming. For deliveries within Germany GEMA fees of 0,24€/pc. apply.

📏 5,7 × 1,8 × 0,9 cm

🔧 L2

📦 1,2 × 2,7





 PLASTIC,
 STAINLESS STEEL



1 000 ML



FOOD SAFE



2 COMPARTMENTS



KEEP 2H WARM/
 3H COLD



1521

Lunchbox Milano

Insulating handle man with 1.000ml total capacity (with inserted additional compartment socket capacity approx. 500 ml) with removable additional compartment (350 ml), lid and foldable spoon with fork tips. We print your logo on the lid.

✂️ ø 13 × 16 cm

📦 T4

📅 5 × 3

 PLASTIC,
 STAINLESS STEEL



1 000 ML



FOOD SAFE



2 COMPARTMENTS



KEEP 2H WARM/
 3H COLD



2654

Lunchbox Villach

Insulating lunchbox made of stainless steel and plastic. In addition to the main chamber (capacity 1,000ml), it has an additional stainless steel insert and a practical handle on the lid. Your logo will be engraved on the lunchbox.

✂️ ø 13,3 × 18 cm

📦 L3

📅 5 × 4



PLASTIC, SILICON,
STAINLESS STEEL

2 x 500 ML

FOOD SAFE



2 COMPARTMENTS



0931

Lunch box Home

Perfect for lunch, box in stainless steel with two compartments and plastic carrying handle. We print your logo on the lid.

 15 x 14,8 cm

 T4

 5 x 3

PLASTIC,
BOROSILICATE

GLASS
700 ML

BPA FREE

FOOD SAFE



2633

Food storage container Odense

Fresh storage container made of borosilicate glass with a lockable lid and silicone seal. Suitable for microwave and freezer, food safe and easy to stow away. Your logo will be printed on the lid.

✂ 15,7 × 15,7 × 6,5 cm
☒ T3
☒ 5 × 3

ECO

STAINLESS STEEL,
BAMBOO

1 200 ML

FOOD SAFE



2313

Lunch box Diest

Stainless Steel lunch box with bamboo lid, bamboo cutlery and an elastic strap. Your logo will be engraved onto the lid.

✂ 18 × 13 × 7,2 cm
☒ L3
☒ 6 × 4

PLASTIC,

600 ML

BPA FREE

FOOD SAFE



2659

Lunchbox Vigo

Lunchbox made of polypropylene (BPA free). Thanks to the integrated cutlery, the box is the perfect companion. The box is dishwasher and microwave safe. Please note: the logo is not dishwasher-safe. Your logo will be printed on the lid.

✂ 16,4 × 11 × 5 cm
☒ T4
☒ 5 × 3





PLASTIC,
SILICON



850 ML



PHONE STAND, BPA
FREE



FOOD SAFE



04



05

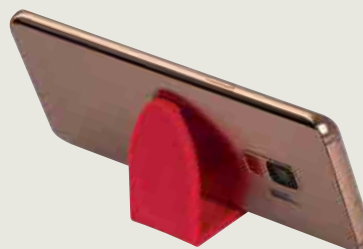

0904

Plastic box Goya

Lunch box with steam valve, removable divider and cell phone holder.
Capacity 850 ml. Suitable for microwave and dishwasher. Please note: The
advertising is not dishwasher safe. We print your logo on the lid.

✂ 19,1 × 11,9 × 6,4 cm

☒ T4

☒ 5 × 3



ECO



STAINLESS STEEL



700 ML



FOOD SAFE



2526

Lunchbox Sint-Truiden

Durable, environmentally friendly and robust lunch box (capacity 700 ml) made of stainless steel with a lid that can be closed with a clamp on both sides. Your logo will be engraved on the lid.

✂ 17,2 × 12 × 5,6 cm

☒ L3

☒ 5 × 3



ECO



STAINLESS STEEL



700 + 450 ML



2 COMPARTMENTS



FOOD SAFE



2529

Double Tier Lunch Box Porto Alegre

Double tier, durable, environmentally friendly and robust lunch box (bottom 700 ml capacity, top 450 ml capacity) made of stainless steel with a lid that can be closed with a clamp on both sides. Your logo will be engraved on the lid.

✂ 17,5 × 12 × 8,3 cm

☒ L3

☒ 5 × 3

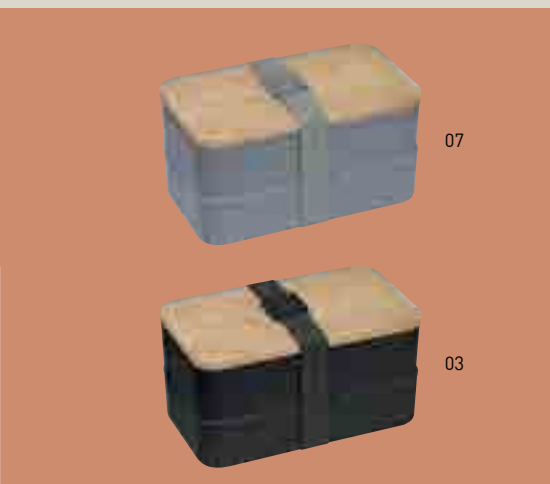

07

03



ECO



BAMBOO, PLASTIC



2x600 ML



2 COMPARTMENTS,
BPA FREE



FOOD SAFE

2531

Lunch box Pescara

Nice lunch box set made of polypropylene (BPA free, 600 ml capacity each) with a bamboo lid. The set consists of two separate boxes, an individually usable divider, cutlery (knife, fork and spoon) in the lower lid and an elastic band to close the set. Your logo will be engraved on the bamboo lid.

✂ 18,6 × 10,6 × 9,8 cm

☒ L3

☒ 6 × 4





ECO



BAMBOO, MARBLE



FOOD SAFE



2748

Cutting board San Diego

Visually appealing cutting board with a mix of materials. Half of it is made of bamboo and the other half of marble. An eye-catcher in every area. We will apply your logo to the bamboo side by means of laser engraving.

- ✂ $\varnothing 25 \times 1,1$ cm
- 📏 L3
- 📦 6 x 4



ECO



BAMBOO



FOOD SAFE



1559

Bamboo chopping board Gdansk

Large chopping board made of bamboo - ideal for cutting roast meat or snacks. Your logo will be engraved on the bottom right corner.

- ✂ 38 x 28 x 1 cm
- 📏 L3
- 📦 5 x 3



ECO

BAMBOO,
STAINLESS STEEL

KNIFE INCLUDED



FOOD SAFE



7633

Cutting board with knife Mantova

Beautiful cutting board made of bamboo with integrated universal knife made of stainless steel. The knife is fixed by a magnet in the recess. We apply your logo by means of laser engraving on the blade of the knife.

- ✂ 33 x 30 x 2 cm
- 📏 L3
- 📦 4 x 4



3388

Wooden board with knife Lizzano

Excellent duo! Wooden board made of beech with integrated knife. We apply your logo on the board by means of laser engraving.

✂ 30,5 × 23 × 1,9 cm

📦 L3

📦 5 × 3



ECO



BEECH WOOD



KNIFE INCLUDED



FOOD SAFE



ECO



BAMBOO



3161

Foldable trivet Rotterdam

Foldable pot or pan trivet with water and food repellent surface, ideal for camping or outdoor activities. Your logo will be engraved directly on the trivet.

✂ 15,8 × 14,3 × 1,5 cm

📦 L2

📦 5 × 1



ECO



BAMBOO



FOOD SAFE



3727

Bamboo Cutting Board Bratislava

Bamboo cutting board with integrated metal handle. Your logo will be laser engraved on the board.

✂ 42 × 25,5 × 2 cm

📏 L3

📦 8 × 5



ECO



BAMBOO



FOOD SAFE



0973

Bamboo board Bressanone

Stable bread board made of bamboo. Your logo will be engraved.

✂ 25 × 18 × 1,5 cm

📏 L3

📦 4 × 3





ECO



BAMBOO



INCLUDE BATTERIES



2442

Kitchen scale Herentals

Digital Bamboo kitchen scale with black surrounded display. The maximum loading weight is 5 kg and notifications can be shown in kg/g/oz, precisely up to 1g. Your logo will be engraved on the bamboo surface.

✂ 16,1 × 23 × 1,9 cm

🔋 L3

📦 5 × 3



ECO

RUBBER WOOD,
METAL

FOOD SAFE



3283

Cheese board Pesca

Cheese board made of wood (rubberwood), includes a cheese knife, a cheese fork, and a waiter's knife. We engrave your logo on the board.

✂️ ø 19 × 3,5 cm

📏 L3

📦 5 × 3



ECO

BAMBOO, SLATE,
STAINLESS STEEL

FOOD SAFE

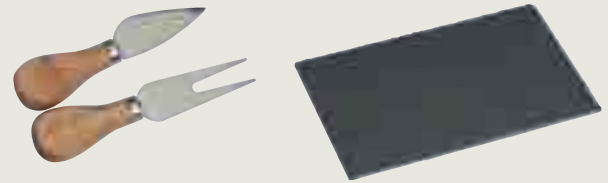

0599

Cheese board with slate plate Calais

Cheese board made of bamboo in the form of a wine bottle with a slate that can be inserted, a cheese knife and a cheese fork. We engrave your logo onto the slate.

✂️ 44,3 × 15,4 × 2,5 cm

📏 L3

📦 5 × 5

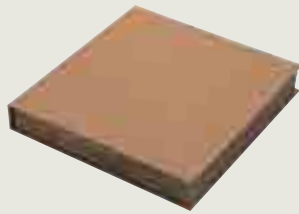

ECO



RUBBER WOOD,
METAL



FOOD SAFE



0191

Cheese set with wooden cutting board

Cheese set including a round wooden board and a cheese knife made of stainless steel, which can also be used for serving. Your logo will be engraved on the board.

✂ 20,8 × 21,7 × 3 cm

📦 L3

📦 8 × 3



ECO



BAMBOO, METAL



FOOD SAFE

2660

Bamboo bowl with nutcracker Vienna

Beautiful bamboo bowl with metal nutcracker. Give your logo message a particularly tasty setting with this article. We print your logo to the bamboo bowl by laser engraving.

✂ 24 × 17 × 2 cm

📦 L3

📦 5 × 2





ECO



GLASS, BAMBOO



700 ML



FOOD SAFE



2615

Storage jar Osaka

Storage jar made of borosilicate glass with a bamboo lid and silicone ring. With a capacity of 700 ml, this storage jar should not be missing in any kitchen. We laser your logo onto the bamboo lid.

✂️ ø 10,2 × 14,2 cm

📏 L3

📦 5 × 5



ECO



GLASS, BAMBOO



1 000 ML



FOOD SAFE



2616

Storage jar Ontario

Storage jar made of borosilicate glass with a bamboo lid and silicone ring. With a capacity of 1,000 ml, this storage jar should not be missing in any kitchen. We laser your logo onto the bamboo lid.

✂️ ø 10,2 × 17,2 cm

📏 L3

📦 5 × 5



ECO



CERAMIC, BAMBOO



750 ML



FOOD SAFE



2620

Ceramic jar Nijmegen

Ceramic storage jar with bamboo lid and silicone ring. With a capacity of 750 ml, this storage jar should not be missing in any kitchen. We laser your logo onto the bamboo lid.

✂️ ø 10,2 × 18 cm

📦 L3

📦 4 × 4



ECO



GLASS, BAMBOO



300 ML



FOOD SAFE



2279

Universal bowl Bouillon

Universal bowl made of borosilicate glass with securely closing bamboo lid and a filling capacity of 300 ml. Your logo will be engraved on the lid.

✂️ ø 13,1 × 5,6 cm

📦 L3

📦 ø 5



ECO



BAMBOO, COTTON



FOOD SAFE

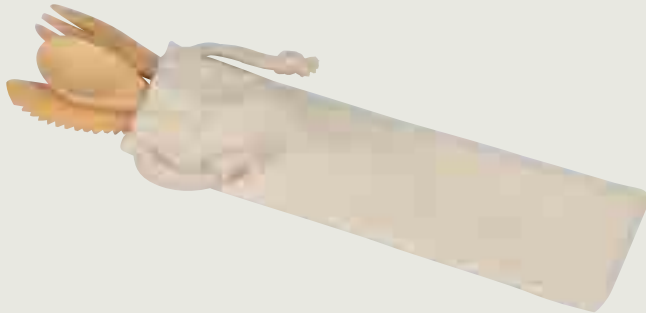

2585

Bamboo Cutlery Bonneville

Environmentally friendly bamboo cutlery consisting of a fork, knife and spoon in a cotton pouch. Ideal to carry and therefore especially suitable for camping or other outdoor activities. The logo is printed on the pouch.

✂ 6,5 × 1,5 × 21,5 cm

☒ TT1

☒ 3 × 10

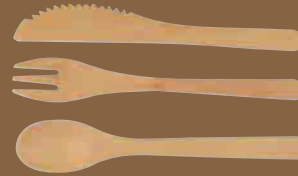

ECO



WOOD,
STAINLESS STEEL



FOOD SAFE



3582

Cutlery set Marrakesh

Cutlery set consisting of fork, knife and spoon made of wood and stainless steel in a lockable cotton pouch. Your logo will be printed on the pouch.

✂ 5,7 × 1,7 × 23,5 cm

☒ TT1

☒ 15 × 4



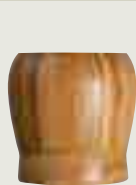

ECO

BAMBOO

FOOD SAFE



2904

Wooden mortar Salvador

Shapely wooden mortar made of bamboo with matching pestle. Not only a practical helper in every kitchen, but also an eye-catcher with your logo message. We engrave your logo on the mortar.

✂ $\varnothing 9,7 \times 9,9$ cm

☒ L3

☒ 3,5 x 3



ECO



PINE WOOD, TITAN



14 PIECES



FOOD SAFE

2987

Knife block Berlin

14-piece knife block set with titanium-coated blades and a solid holder made of wood (pine). The perfect accessory for every well-equipped kitchen and an excellent platform for your logo. We engrave this on the knife block.

🔪 11 × 15 × 33,5 cm

📏 L3

📦 6 × 4

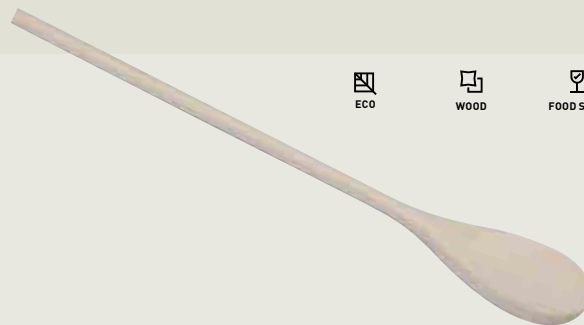

2525

Cooking Spoon Alvorada

Eco-friendly wooden cooking spoon, a sustainable and durable all-purpose weapon in any kitchen. The logo is applied by engraving on the style.

✂ 30,2 × 4,1 × 0,9 cm

☒ L1

☒ 6 × 0,6



2440

Cooking spoon Menemen

Sustainable, durable and environmentally friendly cooking tool made of bamboo which can also be used as a pan turner. We will engrave your logo on the handle.

✂ 25,1 × 5 × 0,5 cm

☒ L1

☒ 5 × 1,5



ECO

BAMBOO

SALAD SPOON
AND FORK

FOOD SAFE

2780

Bamboo salad servers Capua

Nice salad cutlery made of bamboo. We engrave your logo on the handle of the spoon.

✂ 30,3 × 6 × 2,1 cm

☒ L2

☒ 5 × 1,5



PLASTIC,
STAINLESS STEEL

OPENER FOR:
CANS, BOTTLES, JARS

FOOD SAFE



1371

Multi-opener Odessa

The almost all-purpose opener simplifies the opening of cans, bottles and jars. It makes life easier! We print your logo on the white surface.

✂ 5,5 × 2,7 × 14,5 cm

🌀 T2

📦 4 × 0,8

PORCELAIN,
SILICON

FOOD SAFE



05



11

8894

Porcelain pot with silicone lid and heat protected handles

Porcelain pot (suitable for dishwasher, oven and microwave), with heat resistant silicone handles (up to 250 °C). Your logo will be printed on the pot in ceramic transfer.

✂ 14,8 × 10,2 × 7 cm

🌀 C1

📦 4 × 3

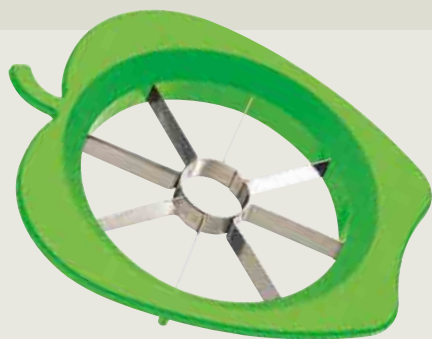

**PLASTIC,
STAINLESS STEEL**

FOOD SAFE

3322

Apple cutter Apple Valley!

Healthy snack! As everyone knows: an apple a day, keeps the doctor away! This is guaranteed with this great apple cutter. Attach, push down and enjoy the healthy snack. We will place your logo on the edge. Single-packed in poly bag.

✂ 13 × 14,7 × 1,9 cm

🔪 T3

📦 3,5 × 1



**PLASTIC,
STAINLESS STEEL**

FOOD SAFE

3026

Chive scissors Bilbao

With this great stainless steel herb scissors you can cut herbs five times faster in the future. We apply your logo on the protective cover by means of pad printing.

✂ 22,2 × 7,8 × 2,6 cm

🔪 T3

📦 5 × 1

**PLASTIC,
STAINLESS STEEL**

3 in 1

FOOD SAFE

1819

3 in 1 Kitchen Tool Aarschot

3 in 1 kitchen tool consisting of a knife, peeler and grater. Your Logo will be printed onto the handle.

✂ 22 × 3,5 × 2,5 cm

🔪 T2

📦 5 × 1





ECO

COTTON



03



05



06



44



1381

Cotton apron Koldby

Serving apron made of 160g/m² Eco Tex cotton in varied colours. Your logo will be printed directly on the apron.

- ✂ 89 × 40 cm
- ✂ ST2
- ✂ 15 × 15



ECO

COTTON



03



05



06



44



1383

Cotton apron Mjolden

Cooking apron made of 160g/m² Eco Tex cotton in varied colours. Your logo will be printed directly on the apron.

- ✂ 71 × 86 cm
- ✂ ST2
- ✂ 9 × 15



03



05



06



07



09



13



29



44



ECO



COTTON



0664

Cotton apron Grillmeister

Apron made of 170g/m² Eco Tex cotton in varied colours. Your logo will be printed directly on the apron.

✂ 64,5 × 0,3 × 90 cm

✂ ST2

✂ 20 × 15





ECO



WOOD,
STAINLESS STEEL,
POLYESTER



FOOD SAFE



2584

Barbeque Set Belfast

Barbeque set consisting of a cutting board, a barbecue turner, a meat fork and a meat knife in a 600D polyester carrier bag with handles. Your logo will be printed on the bag.

✂ 36,3 × 15,2 × 3,3 cm

☒ TT2

☒ 8 × 12



8077

Barbecue set Aurora

Nylon apron with grill glove, stainless steel fork, tongs and turner with wooden handle. We print your logo on the apron.

- ✂ 74 × 50 × 2 cm
- ☒ TT3
- ☑ 15 × 10



TOP PRICE

0648

Barbecue case Oval Plate

TOP PRICE! Barbecue case consisting of barbecue tongs, meat fork and barbecue turner in metal case. We laser your logo on the oval metal plate of the case.

- ✂ 37 × 10 × 8 cm
- ☒ L3
- ☑ 5 × 2,5



3187

Barbecue set Eindhoven

Barbecue set consisting of a large wooden board, two knives with stainless steel blade, barbecue tongs, meat fork and a knife sharpener in a polyester case. Your logo will be printed on the case.

- ✂ 38,8 × 21,4 × 4,4 cm
- ☒ TT2
- ☑ 10 × 10





 STAINLESS STEEL,
 WOOD





 FOOD SAFE



0833

Carving knife and fork Sydney

Classy carving knife and fork composed of a carving knife, a fork and a blade sharpener. Packed in a nice wooden box. Your logo will be printed on the wooden box.

 37 × 14,8 × 3,9 cm
 T4
 5 × 3





 WOOD,
 STAINLESS STEEL,
 WOOD, CARDBOARD





 FOOD SAFE



3561

Steak knife set London

Story of meat! For the perfect steak you need the perfect knives, otherwise your steak will look more or less like minced. This steak knife set is made of stainless steel and the quality is just awesome. The packing will make the set even better. We will pad print your logo onto the packing.

 14,9 × 25,4 × 2,2 cm
 S1
 3,5 × 2





 STAINLESS STEEL





 FOOD SAFE



3555

Salt and pepper mill Rome

Spice it up! Spice up your customer relationship with this nice 2-in-1 salt and pepper mill. The stainless steel and plastic made mill features two adjustable ceramic grinders. Rough salt and fresh pepper are easily grinded. We will engrave your logo centered on one stainless steel lid on one side. Single-packed in box.

 ø 5,2 × 22 cm
 L3
 ø 3



WOOD, SILICON,
ALUMINIUM

FOOD SAFE



0580

Burger press with silicone brush Texas

Aluminum burger patty press with silicone brush, packed in an individual box. We stick your logo with a label on the box.

21 × 27 × 3,6 cm

ETN1

4 × 5



PLASTIC, METAL

ADJUSTABLE FLAME,
REFILLABLE

0045

Creme Brulee torch

Refillable "creme brulee" torch with regulabe flame size and kids security. We will print your logo onto the shaft.

✂ 6 × 3,5 × 11,2 cm
 ⚙ T3
 ☞ 5 × 1,2



PLASTIC, METAL

ADJUSTABLE FLAME,
REFILLABLE

6016

Metal stick lighter Brisbane

This slim table lighter is ideal for safely lighting candles, grill, storm lights and many other items. The lighter is refillable and looks extremely good on the table.

✂ 17,6 × 1,5 × 1,1 cm
 ⚙ L2
 ☞ 4,5 × 1



STAINLESS STEEL

ADJUSTABLE FLAME,
REFILLABLE



03



06

3167

Lighter with attachment for candles Beijing

Electronic lighter with black head and jet flame, refillable. The flame size is infinitely variable. Your logo will be printed on one side.

✂ 2,5 × 1,18 × 12,2 cm
 ⚙ T1
 ☞ 5 × 1,8



PLASTIC

MICRO-USB,
USB-A

3573

Table lamp Montes Claros

Plastic table lamp with touch function, infinitely dimmable and rechargeable battery. Your logo will be attached to the lampshade.

✂ ø 10,5 × 25,7 cm

☒ T4

☒ 4 × 3



ECO

GLASS, BAMBOO

3165

Candle in frosted glass with bamboo lid Metz

Candle in an elegant frosted glass with bamboo lid, decorative and versatile. Your logo will be engraved on the lid.

✂ ø 6,7 × 8 cm

☒ L3

☒ ø 5



ABS, PLASTIC

LED, COLOR
CHANGING

2638

Humidifier Nucia

Aroma humidifier with color-changing LED light made of plastic with a wood look. The humidifier has a capacity of approx. 130 ml and can be enriched with essential oils. The humidifier is operated with the included USB cable. We will print your logo on the humidifier.

✂ ø 9 × 8,9 cm

☒ T3

☒ 3 × 1,5



 PORCELAIN
 FOOD SAFE





0554

Chocolate fondue set Stamford

Chocolate fondue set made of porcelain, including 2 fondue forks. Dip fruits or biscuits into the chocolate and enjoy this beautiful gift set. Your logo will be printed on a label and stuck on the single box.

 ø 11,3 × 13,8 cm
 ETN1
 5 × 5





 CERAMIC
 300 ML
 FOOD SAFE



0843

Ceramic cup Trapani

Nostalgia cup made of ceramic with black rim and 300 ml filling capacity. Your logo will be printed via ceramic transfer onto the mug.

 ø 8,9 × 8,2 cm
 C1
 5 × 5





7888

Ceramic mug Bangalore

Mug made of ceramic in tankard look with 300 ml capacity. We print your logo by ceramic transfer on the right or left of the handle on the cup. All-round printing possible on request.

- ✂ $\varnothing 8 \times 9,5$ cm
- ☒ C1
- ☒ 4 × 3

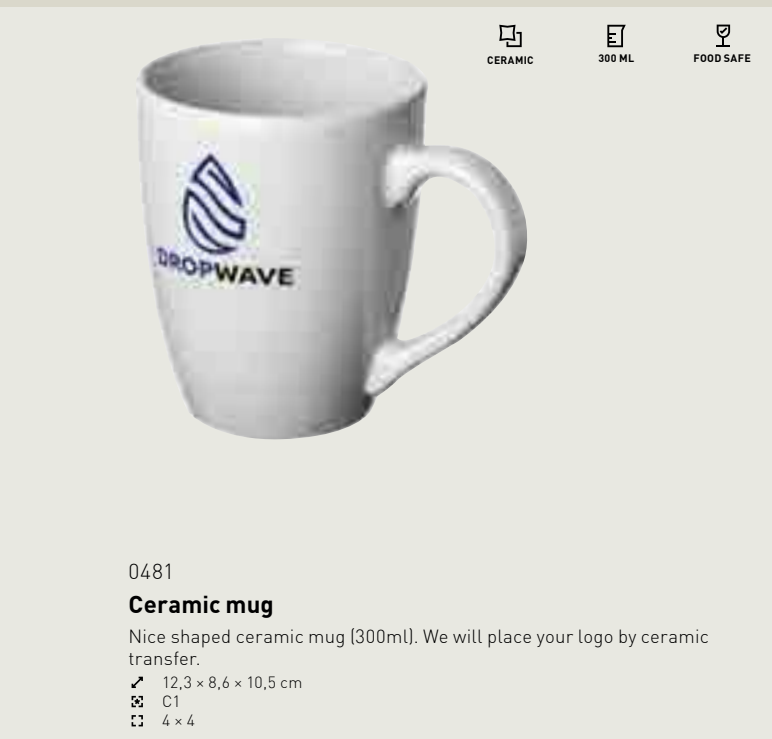

0481

Ceramic mug

Nice shaped ceramic mug (300ml). We will place your logo by ceramic transfer.

- ✂ 12,3 × 8,6 × 10,5 cm
- ☒ C1
- ☒ 4 × 4

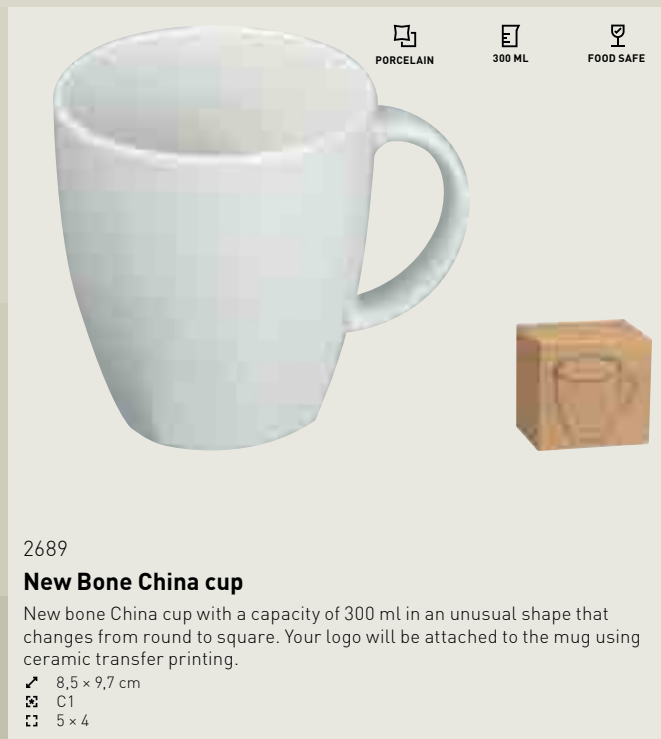

2689

New Bone China cup

New bone china cup with a capacity of 300 ml in an unusual shape that changes from round to square. Your logo will be attached to the mug using ceramic transfer printing.

- ✂ 8,5 × 9,7 cm
- ☒ C1
- ☒ 5 × 4



CERAMIC



300 ML



DISHWASHER SAFE



FOOD SAFE



SUBLIMATION
CMYK PRINT



1277

Sublimation mug Vieste

Ceramic cup - capacity 300 ml. Your logo will be sublimation printed all around the cup. Thanks to the special coating, your logo can withstand up to 3,500 washings in the dishwasher.

- ✂ ø 8,2 × 9,9 cm
- ☒ SU
- ☒ 19 × 8



CERAMIC



300 ML



COLOUR CHANGING



FOOD SAFE



SUBLIMATION
CMYK PRINT



03



04



05



3438

Colour-changing sublimation mug Sirmione

It's magic! Ceramic cup (capacity 300 ml) with color-changing effect. Here, when cold, the print disappears under the colored varnish - as soon as hot liquid is poured in, your print appears. We apply your logo all around the cup. To preserve the brilliance of the printed image, we recommend hand washing.

- ✂ ø 8,2 × 9,6 cm
- ☒ SU
- ☒ 19 × 8



03

04

05

08

09

0872

Cup Thessaloniki

Ceramic mug with 300 ml capacity and colored rubberized outer surface, which gives the mug a particularly nice feel. We laser your logo on the mug.

✂ ø 8,2 × 9,8 cm

☒ L3

☒ 4 × 3

CERAMIC

300 ML

RUBBER COATED

FOOD SAFE

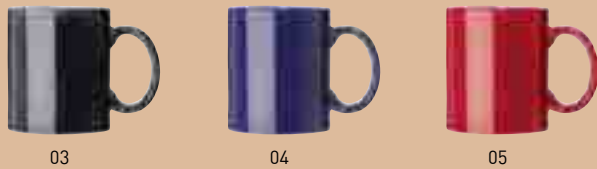

03

04

05

CERAMIC

300 ML

FOOD SAFE



0095

Ceramic coffee mug

Classic coffee mug made of shiny ceramic with 300 ml capacity. Your logo is printed onto the right or left side of the handle by ceramic transfer. Wrap-around printing on request.

✂ ø 8 × 9,5 cm

☒ C3

☒ 4 × 3





 CERAMIC
  300 ML
  FOOD SAFE



8704

Ceramic mug Martinez

Exquisite! Great ceramic mug with a capacity of 300ml which offers the utmost for you with its variety of colours. We will place your logo by means of ceramic transfer on the desired place (left or right from the handle, on the inner rim, on the handle, etc.). Allover and colour-changing print upon request.

 ø 9 × 8,5 cm
 C3
 4 × 4



03

04

05

08

29

 CERAMIC
  250 ML
  FOOD SAFE



04

08



09

10

5095

Coffee cup Palermo

Shapely ceramic cup [capacity 250 ml] with integrated spoon color-coordinated with the interior color of the cup. We apply your logo by means of a ceramic transfer to the right or left of the handle.

 ø 8,5 × 9,8 cm
 C1
 3 × 3



03



04



05



06



09



CERAMIC



300 ML



FOOD SAFE

3728

Ceramic Cup Bradford

Ceramic mug with square handles, matte finish and 300ml capacity. We print your logo on the cup by ceramic transfer. All around printing possible on request.

✂ ø 7,9 × 10,5 cm

☒ C1

☒ 5 × 5



CERAMIC, CORK



300 ML



SUBLIMATION
CMYK PRINT



FOOD SAFE



3825

Sublimation mug San Jose

Sublimation mug with a lid, a capacity of 300 ml and a removable cork base. We will print your logo all around the mug using sublimation printing. Cup and print are dishwasher safe, we recommend hand washing for the lid and the cork base.

✂ 8,8 × 11 cm

☒ SU

☒ 18 × 5



ECO



CERAMIC, CORK



350 ML



FOOD SAFE



2418

Ceramic mug with cork bottom Gistel

Large ceramic coffee cup with a capacity of 350 ml and a removable cork bottom. The logo is applied to the cup by ceramic transfer printing.

✂ 11,3 × ø 8,6 cm

☒ C3

☒ 4 × 4



03



06

GLASS 300 ML FOOD SAFE



0948

Cup Cattolica

Elegant cup made of glass. We will print your logo through ceramic transfer in one position.

- ✂ ø 8,1 × 10,2 cm
- ☒ C3
- ☒ 5 × 5

GLASS 300 ML FOOD SAFE



3331

Glass mug Limerick

Elegant glass in beaker optic. We will print your logo with ceramic transfer on one position.

- ✂ ø 7,9 × 9,5 cm
- ☒ C3
- ☒ 10 × 6

GLASS 300 ML FOOD SAFE



7981

Glass coffee mug Geneva

This glass coffee mug decorates any desk. Trendy transparently frosted design and its capacity of approx. 300 ml will make it become your favourite mug. We will print your logo by means of ceramic transfer left or right of the handle. We recommend hand wash only for printed mugs.

- ✂ ø 8 × 9,4 cm
- ☒ C3
- ☒ 6 × 6





ECO



GLASS, BAMBOO



500 ML



LAKEPROOF



FOOD SAFE



1541

Glass bottle with bamboo lid Santa Cruz

Glass bottle with bamboo lid and 500ml filling capacity. Your logo will be engraved on the lid.

✂ $\varnothing 6,8 \times 24,2$ cm

🔍 L2

📦 5 x 1



BOROSILICATE GLASS



400 ML



LAKEPROOF



LED TEMPERATURE
DISPLAY



FOOD SAFE



3225

Thermal flask Karlstad

Thermal flask made of borosilicate glass with a digital temperature display in the lid, sieve and a capacity of 400 ml. Your logo will be printed onto the glass.

✂ $\varnothing 6,4 \times 24$ cm

🔍 S2

📦 15 x 10



GLASS, ABS



450 ML



LAKEPROOF



FOOD SAFE



1543

Glass bottle with PP cap Sevilla

Glass bottle with PP lid and 450ml filling capacity. Your logo will be engraved on the glass.

✂ $\varnothing 6,8 \times 23,5$ cm

🔍 C3

📦 3,5 x 4



ECO



GLASS, CORK,
BAMBOO



500 ML



LAKEPROOF



FOODSAFE



2783

Glass bottle Skopje

Glass bottle with a capacity of 500ml, a cork sleeve for a particularly pleasant hand feeling and a bamboo lid. We laser your logo onto the cork coating.

✂ $\varnothing 6 \times 23$ cm

📦 L3

📦 3,5 x 5



 GLASS,
STAINLESS STEEL

 500 ML

 LEAKPROOF

 FOOD SAFE

1394

Glass bottle Indianapolis

Trendy glass bottle in different colours, with a 500ml capacity and stainless steel cap. We engrave your logo on the lid.

 ø 6,1 × 21,9 cm

 L2

 ø 3,5





 GLASS, NEOPREN, STAINLESS STEEL
  500 ML
  LEAKPROOF
  FOOD SAFE



0842

Glass bottle Klagenfurt

Leak-proof drinking bottle made of glass with stainless steel lid and a capacity of 500 ml. The bottle is delivered in a matching neoprene sleeve with carrying strap. We print your logo in the center of the sleeve. Engraving on the lid or bottle and printing on the bottle possible on request.

 ø 7 × 22,3 cm
 TT1
 10 × 4



TRITAN,
ALUMINIUM

900 ML

LEAKPROOF,
BPA FREE

FOOD SAFE



1386

Drinking bottle Aversa

Large drinking bottle made of TRITAN, with 900ml capacity and aluminium lid. We engrave your logo on the lid.

- ✂ $\varnothing 7,4 \times 26,7$ cm
- ☒ T2
- ☒ 3,5 x 3,5



TRITAN

2 500 ML

LEAKPROOF,
BPA FREE

FOOD SAFE



0814

Infuser bottle Crotone

Large drink dispenser made of plastic with lockable spout, carrying handle, sieve insert for e.g. fruits, and 2500 ml capacity. We will print your logo on the lower area of the bottle.

- ✂ $\varnothing 11,5 \times 29,5$ cm
- ☒ T4
- ☒ 4 x 3



PLASTIC

700 ML

LEAKPROOF,
BPA FREE

FOOD SAFE



0862

Drinking bottle Saint-Denis

Large, leak-proof drinking bottle BPA-FREE (capacity 700 ml) with removable fruit insert. In the lid is a large drinking opening with closure and a carrying handle integrated. We print your logo on the bottle.

- ✂ $\varnothing 7 \times 24$ cm
- ☒ T4
- ☒ 3 x 4



TRITAN

850 ML

LEAKPROOF,
BPA FREE, STRAW

FOOD SAFE



0815

Drinking bottle Sólter

BPA-free drinking bottle with 850ml capacity, great design, infuser, and integrated drinking straw. We pad print your logo on the bottle.

- ✂ 24 x $\varnothing 8,3$ cm
- ☒ T4
- ☒ 4,5 x 3,5



PLASTIC



650 ML



LEAKPROOF,
BPA FREE



FOOD SAFE

0008

Drinking bottle Toulon

Plastic drinking bottle with infuser for (e.g.) fruits and 650ml capacity. We will print your logo on the bottle.

✂ $\varnothing 7 \times 25$ cm

☒ T4

☒ 3 × 5

PLASTIC,
STAINLESS STEEL

700 ML

LEAKPROOF

FOOD SAFE



0848

Drinking bottle Elwood

Leak proof drinking bottle (capacity 700 ml) made of plastic with stainless steel cap and bottom. Your logo will be printed on the bottle. Engraving on the lid possible on request.

✂ $\varnothing 7 \times 26,5$ cm

🔍 T4

📏 3,5 x 3,5

PET

700 ML

LEAKPROOF,
STRAW,
BPA FREE

FOOD SAFE



2784

Sports drinking bottle Sion

Sports bottle (700 ml capacity) made of PET with a straw, foldable drinking device and stainless steel ring. We will print your logo on the bottle.

Engraving on the stainless steel ring is possible on request.

✂ $\varnothing 8 \times 24,5$ cm

🔍 T4

📏 3,5 x 3,5



STAINLESS STEEL,
PET

780 ML

LEAKPROOF

FOOD SAFE



04

05

10

24

29

66

77

2908

Drinking bottle Sapporo

Drinking bottle made from PET with a capacity of 780 ml. We will print your logo on the bottle. Engraving on the stainless steel lid is possible on request.

✂ $\varnothing 7,3 \times 24,6$ cm

🔍 T4

📏 3,5 x 3,5



 PET, ALUMINIUM

 400 ML

 LEAKPROOF

 FOOD SAFE

2437

Bottle Mechelen

PET bottle with a leak-proof lid, carabine hook and a capacity of 400ml. Your logo will be printed onto the bottle.

 ø 6,5 × 17,5 cm

 T4

 3,5 × 3,5





ALUMINIUM,
PLASTIC

800 ML

LEAKPROOF,
SNAP HOOK

FOOD SAFE



03

04

05

06

07

08

10

29

44

0194

800ml Drinking bottle with snap hook

Leak-proof drinking bottle made of aluminum with carabiner and a capacity of 800 ml. Your logo will be lasered on the bottle.

✂ $\varnothing 7,3 \times 24,5$ cm

☒ L3

☒ 4 x 4



ALUMINIUM,
PLASTIC

500 ML

LEAKPROOF,
SNAP HOOK

FOOD SAFE



03

04

05

06

07

08

10

29

44

0195

500ml Drinking bottle

Leak proof aluminum water bottle with carabiner and 500ml capacity. Your logo will be lasered on the bottle.

✂ $\varnothing 7,3 \times 19$ cm

☒ L3

☒ 4 x 4



ALUMINIUM,
PLASTIC

600 ML

LEAKPROOF,
STRAW

FOOD SAFE



04

05

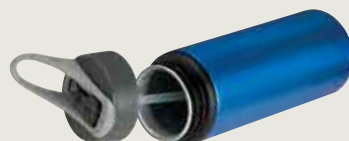

0982

Insulated flask Green Tea

Stainless steel vacuum flask with integrated straw. Your logo will be engraved.

✂ $\varnothing 7,8 \times 31,5$ cm

☒ L3

☒ 4 x 4



ALUMINIUM,
PLASTIC

600 ML

LEAKPROOF

FOOD SAFE

04 05 07

5710

Metal drinking bottle Charlotte

Satisfy your thirst en route! This 0.6l aluminium drinking bottle with a sports cap is the ideal companion when cycling, hiking, etc.. These bottles look great with their metallic lacquering. Your logo will be laser engraved on the bottle. Each bottle is packed in a single cardboard box.

- ✂ ø 7,2 × 20,5 cm
- 📦 L3
- 📦 4 × 4

ALUMINIUM

750 ML

LEAKPROOF

FOOD SAFE

1514

Aluminium drinking bottle San Marino

Metal drinking bottle with lockable lid and 750ml filling capacity. Your logo will be engraved on the bottle; color print on request.

- ✂ ø 5,8 × 21 cm
- 📦 L3
- 📦 4 × 4

SUBLIMATION

Using the sublimation technique for branding promotional items is its ability to display graphics over large surface areas seamlessly. This allows businesses to create visually striking and attention-grabbing promotional products that make a strong impact on their target audience. The versatility and scope for creativity with sublimation make it a popular choice for companies aiming to elevate their brand visibility through unique and captivating advertising gifts.

- STAINLESS STEEL
- 300 ML
- SUBLIMATION CMYK PRINT
- FOOD SAFE



3835

Sublimation mug Sofia

Drinking cup made of stainless steel with colored aluminum carabiner and a capacity of 300 ml. We will print your logo all around the cup using sublimation printing.

- ø 7,5 × 9,2 cm
- SU
- 16 × 8





- STAINLESS STEEL
- 500 ML
- SUBLIMATION
CMYK PRINT
- FOOD SAFE

3832

Sublimation cup Sao Paulo

Double-walled insulating mug made of stainless steel with a capacity of 500 ml. We will print your logo all around the mug using sublimation printing.

- ✂ $\varnothing 7,5 \times 21,7$ cm
- ☒ SU
- ☒ 15 x 8



- STAINLESS STEEL
- 750 ML
- SUBLIMATION
CMYK PRINT
- FOOD SAFE

3828

Sublimation bottle Santiago

Drinking bottle made of stainless steel with a capacity of 750 ml. We will print your logo all around the bottle using sublimation printing.

- ✂ $\varnothing 7 \times 26$ cm
- ☒ SU
- ☒ 15 x 8



-  ECO
-  STAINLESS STEEL, BAMBOO
-  800 ML
-  LAKEPROOF
-  FOOD SAFE



2294

Drinking bottle Bingöl

Stainless steel drinking bottle featuring a leak-proof bamboo lid, carrying strap and a capacity of 800ml. Your logo will be engraved onto the bottle.

-  ø 7,2 × 24,5 cm
-  L3
-  4 × 4



-  ECO
-  STAINLESS STEEL, WOOD
-  300 ML
-  LEAKPROOF
-  FOOD SAFE





04 05 07

2972

Drinking Bottle Oslo

Stainless steel drinking bottle with a capacity of 300 ml and a wooden lid. Due to its size, it fits in every pocket and is therefore the ideal companion. We will apply your logo to the bottle by means of laser engraving. Engraving on the lid possible on request.

-  ø 7 × 15 cm
-  L3
-  4 × 4



03

05

44

3478

Set fleece blanket + thermal flask Liverpool

Perfect duo! Your customers will have all they need for a cuddly evening or a journey with this nice set. You will receive a nice 2-in-1 fleece blanket, which can be converted to a pillow by means of the attached zipper and a thermal flask with 500 ml content. We will either engrave your logo on the flask or by means of embroidery on the blanket. Single-packed in box.

- ✂ 30 × 40 × 8 cm
- 📦 L3
- 📦 4 × 4

📦
STAINLESS STEEL,
CARDBOARD, FLEECE

📦
500 ML

📦
LEAKPROOF, VACUUM,
BLANKET SIZE:
180 × 120 CM

📦
FOOD SAFE



3571

Gift set with drinking bottle and lunch box Québec

Gift set in environmentally friendly packaging, consisting of a lunch box (aluminium with a lockable bamboo lid) and a drinking bottle (stainless steel with a capacity of 300 ml). Your logo will be engraved onto the lunch box and the bottle.

- ✂ 21 × 21 × 11,2 cm
- 📦 L8
- 📦 4 × 4

📦
ECO

📦
STAINLESS STEEL,
WOOD

📦
300 ML

📦
LEAKPROOF

📦
FOOD SAFE



3572

Gift set with drinking bottle, lunch box and jute cooler bag Reims

Gift set in environmentally friendly packaging, consisting of a lunch box (aluminium with a lockable bamboo lid), a jute cooler bag and a drinking bottle (stainless steel with a capacity of 500 ml). Your logo will be engraved onto the lunch box and the bottle.

- ✂ 30 × 30 × 13,2 cm
- 📦 L8
- 📦 4 × 4

📦
ECO

📦
STAINLESS STEEL,
WOOD, JUTE

📦
500 ML

📦
LEAKPROOF

📦
FOOD SAFE



STAINLESS STEEL,
PLASTIC

500 ML

VACUUM,
LAKEPROOF,
DOUBLE-WALLED

KEEP 24H WARM/
36H COLD

FOOD SAFE



TOP PRICE



5403

Stainless steel isolating flask Cleveland

Double wall stainless steel isolating flask with 0,5l content. The snap closure allows fast pouring into the cup. Your logo will be laser engraved on the flask. Each isolating flask is packed in a single cardboard box.

✂ $\varnothing 7,4 \times 24,7$ cm

📦 L3

📦 4 x 4



STAINLESS STEEL,
PLASTIC

500 ML

VACUUM,
LAKEPROOF

KEEP 24H WARM/
36H COLD

FOOD SAFE



0429

Insulated bottle Babylon

Stainless steel vacuum flask with 500ml filling capacity and integrated cup in the lid. Your logo will be engraved.

✂ $\varnothing 6,7 \times 24,5$ cm

📦 L3

📦 3 x 3



STAINLESS STEEL,
PLASTIC

1000 ML

VACUUM,
LAKEPROOF,
DOUBLE-WALLED

KEEP 24H WARM/
36H COLD

FOOD SAFE



TOP PRICE

5401

Stainless steel isolating flask Virginia Beach

The huge one! This isolating flask is just the right size - its 1l capacity is ideal for journeys with a couple of people. A double wall stainless steel isolating flask with snap closure and drinking cup. The ideal present on which your logo will be laser engraved on the flask. Each flask is packed in a single cardboard box.

 ø 8 × 33 cm

 L3

 4 × 4



STAINLESS STEEL,
PLASTIC

500 ML

VACUUM,
LAKEPROOF,
DOUBLE-WALLED

KEEP 24H WARM/
36H COLD

FOOD SAFE



3729

vacuum bottle Bucharest

Vacuum insulated bottle with a capacity of 500 ml. The drinking bottle has a matte finish, a drinking device with quick release and safety lock. Your logo will be engraved on the bottle.

∅ 6,2 × 23,5 cm
L3
5 × 5



STAINLESS STEEL,
PLASTIC

500 ML

VACUUM,
LAKEPROOF

KEEP 24H WARM/
36H COLD

FOOD SAFE



0430

Stainless steel thermal flask

Stainless steel vacuum flask (500ml) with the perfect design drinking mug. Your logo will be laser engraved onto the bottle.

∅ 7 × 25,2 cm
L3
5 × 5



STAINLESS STEEL,
PLASTIC

500 ML

VACUUM,
LAKEPROOF,
DOUBLE
WALLED

KEEP 24H WARM/
36H COLD

FOOD SAFE

%

TOP PRICE



03



04



05

5420

Stainless steel isolating flask Albuquerque

Stylish stainless steel isolating flask with 0,5l capacity, a removable drinking cup in matt-coloured burned-in lacquering. Your logo will be laser engraved in silver. Each flask is packed in a single cardboard box.

∅ 7 × 24 cm
L3
5 × 5





 STAINLESS STEEL,
 PLASTIC



 500 + 400 ML



 KEEP 2H WARM/
 3H COLD



 VACUUM,
 DOUBLE-WALLED,
 LEAKPROOF



 FOOD SAFE

2696

Set of vacuum flask and drinking cup Split

Set consisting of a vacuum insulated jug made of stainless steel (capacity 500 ml) with a leak-proof quick-release fastener and a double-walled thermal drinking cup made of stainless steel with a capacity of 450 ml. Your logo will be engraved on the jug.

✂ 14 × 8,5 × 25,5 cm

📦 L3

📦 5 × 5





 STAINLESS STEEL



 500 ML



 VACUUM,
 LAKEPROOF,
 DOUBLE WALLED



 KEEP 24H WARM/
 36H COLD



 FOOD SAFE

2893

Thermo flask Auckland

Noble! Your customers will love this fancy stainless steel thermo flask with 0.5 l capacity and fast closure. Its unique design by the black lacquering makes it the perfect logo item. We will engrave your logo on the flask. Single-packed in poly bag.

✂ ø 6,9 × 23,5 cm

📦 L3

📦 3 × 3





STAINLESS STEEL,
PLASTIC



550 ML



VACUUM,
DOUBLE WALLED



KEEP 8H WARM/
12H COLD



FOOD SAFE



1568

Stainless steel mug with wooden look Costa Rica

Double-walled, stainless steel vacuum mug with 550ml capacity. Your logo will be engraved on the bottle.

✂ \varnothing 9,5 × 18,3 cm

☒ L3

☒ 4 × 4



STAINLESS STEEL,
PLASTIC



500 ML



LAKEPROOF,
VACUUM,
DOUBLE WALLED



KEEP 24H WARM/
36H COLD



FOOD SAFE

STAINLESS STEEL,
PLASTIC



380 ML



VACUUM,
DOUBLE WALLED



KEEP 4H WARM/
6H COLD



FOOD SAFE



1582

Stainless steel bottle with wooden look Tampa

Double-walled, stainless steel vacuum bottle with 500ml capacity. Your logo will be engraved on the bottle.

✂ \varnothing 7,5 × 26 cm

☒ L3

☒ 4 × 4

1566

Stainless steel mug with wooden look Brighton

Double-walled, stainless steel vacuum mug with 380ml capacity. Your logo will be engraved on the bottle.

✂ \varnothing 7,7 × 11,5 cm

☒ L3

☒ 4 × 4



- ECO
- STAINLESS STEEL, PLASTIC, BAMBOO
- 400 ML
- LEAKPROOF, DOUBLE-WALLED
- KEEP 2H WARM/ 3H COLD
- FOOD SAFE

1564

Stainless steel mug Bamboogarden

Double-walled stainless steel mug with bamboo coating, leakproof, and 400ml capacity. Your logo will be engraved on the mug.

- ∅ 7,8 × 17,6 cm
- L3
- 5 × 4



- ECO
- STAINLESS STEEL, BAMBOO
- 550 ML
- VACUUM, LEAKPROOF, STRAINER, DOUBLE WALLED
- KEEP 24H WARM/ 36H COLD
- FOOD SAFE

1362

Isolating Flask Valdemoro

Double wall stainless steel isolating flask (vacuum) with bamboo coating, stainless steel cap and 550ml capacity. We engrave your logo on the bamboo coating.

- ∅ 6,8 × 20,5 cm
- L3
- 3 × 3



- ECO
- STAINLESS STEEL, BAMBOO, PLASTIC
- 500 ML
- VACUUM, LEAKPROOF, DOUBLE WALLED
- KEEP 24H WARM/ 36H COLD
- FOOD SAFE

2334

Drinking Bottle Florenville

Double-walled vacuum drinking bottle made of stainless steel with drinking mug, hand loop, bamboo coating and a capacity of 500 ml. Your logo will be engraved onto the bottle.

- ∅ 6,4 × 27,3 cm
- L3
- 4 × 4



-  ECO
-  STAINLESS STEEL, BAMBOO
-  750 ML
-  VACUUM, LAKEPROOF, DOUBLE WALLED
-  KEEP 24H WARM/
36H COLD
-  FOOD SAFE



03 07



3227
Stainless steel bottle Kobe
 Stainless steel bottle with bamboo ring, leak-proof cap and a capacity of 750 ml. Your logo will be engraved on the bottle.
 ✂ $\varnothing 7,1 \times 25,8$ cm
 ☒ L3
 ☒ 4 x 4

-  STAINLESS STEEL
-  550 ML
-  VACUUM, LAKEPROOF, DOUBLE WALLED
-  KEEP 24H WARM/
36H COLD
-  FOOD SAFE



2295
Thermo bottle Bree
 Double walled vacuum stainless steel bottle with leakproof lid and a capacity of 550ml. Your logo will be engraved onto the bottle.
 ✂ $\varnothing 6,7 \times 27,2$ cm
 ☒ L3
 ☒ 4 x 4



44



77



95



STAINLESS STEEL

500 ML

VACUUM,
LAKEPROOF,
DOUBLE WALLED

KEEP 24H WARM/
36H COLD

FOOD SAFE



3226

Vacuum flask Kawasaki

Double-walled vacuum drinking bottle made of stainless steel with a leak-proof cap and a capacity of 500 ml. Your logo will be engraved onto the bottle.

- ✂ ø 7,2 × 22,4 cm
- ☒ L3
- ☒ 4 × 4

STAINLESS STEEL

750 ML

DOUBLE-WALLED,
LAKEPROOF

KEEP 2H WARM/
3H COLD

FOOD SAFE

0888

Thermal flask Montalcino

Elegant double-walled flask made of stainless steel. We engrave your logo on the bottle.

- ✂ ø 7,8 × 31,5 cm
- ☒ L3
- ☒ 4 × 4



PLASTIC



400 ML



DOUBLE-WALLED



KEEP 1H WARM/
1,5H COLD



FOOD SAFE



5610

Plastic cup Fort Worth

Hot or cold? This 0,4l double wall plastic cup with sliding ledge is great for any journey, and keeps your drinks warm or cold. Fits in all car cup holders. Really fancy in metallic silver, blue and red cups. Also available in white which is great for multi colour print. We will put your logo on the left side of the handle. Each cup is packed in a single cardboard box.

✂ 8,4 × 17,2 cm

☒ T4

☑ 3,5 × 3,5



04



05



06



07



09



10



STAINLESS STEEL,
PLASTIC



400 ML



DOUBLE-WALLED



KEEP 1H WARM/
1,5H COLD



FOOD SAFE



5300

Stainless steel thermo cup El Paso

Hot or cold? This 0,4l double wall stainless steel thermo cup with sliding cap is practical for journeys and keeps your drinks warm or cold. Fits in all main car cup holders. Your logo will be laser engraved on the cup. Each thermo cup is packed in a single cardboard box.

✂ 8,7 × 16 cm

☒ L3

☑ 5 × 5



STAINLESS STEEL,
PLASTIC

300 ML

DOUBLE WALLED

KEEP 2H WARM/
3H COLD

FOOD SAFE



2559

Drinking Mug Alessandria

Double-walled drinking cup made of stainless steel with non-slip bottom, handle and a filling capacity of 300 ml. Your logo will be printed on the mug.

✂ 8,5 × 10,6 cm

☞ T4

☞ 4,5 × 3



STAINLESS STEEL,
PLASTIC

400 ML

USB-A

2613

Thermo mug Zürich

Stainless steel mug with USB connection for keeping warm and a capacity of 400ml. Perfect for the car or the workplace. We laser your logo to the left of the handle.

✂ 8,5 × 16 cm

☞ L3

☞ 5 × 4





03



07

 STAINLESS STEEL,
PLASTIC

 500 ML

 KEEP 2H WARM/
3H COLD

 DOUBLE-WALLED

 FOOD SAFE

2914

Stainless steel mug Santander

Extravagant drinking cup made of stainless steel with a capacity of 500 mL. The perfect companion on all journeys. We will print your logo to the cup by means of laser engraving.

 ø 7 × 21,7 cm

 L3

 4 × 4



STAINLESS STEEL,
PLASTIC

500 ML

LEAKPROOF,
VACUUM,
DOUBLE WALLED

KEEP 12H WARM/
18H COLD

FOOD SAFE



03

98



0482

Insulating mug Como

Double-walled, noble stainless steel mug with 500ml capacity; more importantly, leak-proof. Your logo will be engraved.

✂ ø 8 × 18,5 cm

☒ L3

☒ 3 × 3



STAINLESS STEEL,
PLASTIC

250 ML

LEAKPROOF,
DOUBLE WALLED,
BPA FREE

KEEP 1H WARM/
1,5H COLD

FOOD SAFE

1544

Stainless steel mug with lid Roma

Stainless steel mug with leakproof lid (250ml.) Your logo will be engraved on the mug.

✂ ø 6,8 × 13,6 cm

☒ L3

☒ 3 × 3



ECO



STAINLESS STEEL,
BAMBOO



500 ML



VACUUM,
LEAKPROOF,
MOBILE HOLDER



KEEP 2H WARM/
3H COLD



FOOD SAFE



3179

Vacuum insulating flask sheffield, 500ml

Vacuum insulated bottle made of copper with a lower section made of bamboo, leak-proof lid, a carrying handle and a capacity of 500 ml. Your logo will be engraved on the bottle.

✂ ø 6,9 × 22 cm

☒ L3

☒ 4 × 4



ECO



STAINLESS STEEL,
PLASTIC, BAMBOO



500 ML



VACUUM,
DOUBLE WALLED



KEEP 2H WARM/
3H COLD



FOOD SAFE

3123

Thermo mug Cesena

Stylish insulated mug [double-walled, vacuum] in a mix of materials, stainless steel and bamboo. Capacity 500 ml. We engrave your logo in the upper third on the metal part. Engraving on the bamboo part possible on request.

✂ $\varnothing 8,6 \times 18,3$ cm

☒ L3

☒ 4 x 4



06



03



STAINLESS STEEL,
PLASTIC



500 ML



KEEP 2H WARM/
3H COLD



DOUBLE-WALLED



FOOD SAFE



2658

Thermo mug Zadar

Insulated mug with stainless steel coating and a filling capacity of 500 ml. We laser your logo on the outside of the mug.

✂ \varnothing 8,3 x 19 cm

☒ L3

☒ 4 x 4



03

04

05

06

07

09

98

STAINLESS STEEL,
PLASTIC



350 ML



KEEP 2H WARM/
3H COLD



DOUBLE-WALLED



FOOD SAFE



3730

Drinking Cup Buffalo

Matt double-walled drinking cup with drinking device, lockable lid and a filling capacity of 350 ml. We print your logo to the cup by laser engraving.

✂ \varnothing 9,2 x 12,8 cm

☒ L3

☒ 5 x 5





ECO



STAINLESS STEEL,
PLASTIC, CORK



600 ML



KEEP 2H WARM/
3H COLD



DOUBLE-WALLED



FOOD SAFE

2901

Thermo mug Sibenik

Elegant double-walled thermo mug made of stainless steel with a capacity of 600 ml and a stylish cork base. The perfect companion for on the go. We laser your logo onto the cup.

✂ $\varnothing 8,8 \times 17,5$ cm

☒ L3

☒ 4 x 4





ECO



GLASS, BAMBOO



1000 ML



STRAINER



FOOD SAFE



3185

Glass jug with bamboo lid Frankfurt

Glass jug with closable bamboo lid, pouring sieve and a capacity of 1,000 ml. Your logo will be engraved on the lid.

✂ \varnothing 13 × 12,5 cm

📏 L3

📏 \varnothing 5



ECO



BAMBOO

FOR 30 TEA BAGS
(NOT INCLUDED)

3318

Tea box Damaskus

Elegantly packed! With this beautiful tea box made of bamboo, your tea bags are protected from moisture and light. We will engrave your logo on the lid.

✂ 21 × 6,5 × 8,5 cm

📏 L3

📏 6 × 4





2639

French Press Winterthur

French Press made of borosilicate glass with press plunger, bamboo lid and a filling capacity of 350 ml. Your logo will be placed on the jug. Engraving on the lid possible on request.

✂ ø 7,5 × 16,2 cm

☒ C3

☒ 5 × 5



3224

Glass mug Jackson

Borosilicate glass mug with a closable bamboo lid, integrated bamboo spoon and a capacity of 420 ml. Your logo will be engraved onto the lid.

✂ ø 8,4 × 11,6 cm

☒ L3

☒ ø 4

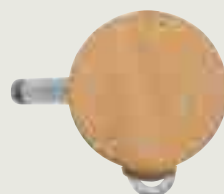



1536

Double-walled glass Zakopane

Double-walled glass with a 500ml filling capacity and bamboo lid. Your logo will be engraved on the lid.

✂ ø 8,7 × 15 cm

☒ L3

☒ 5 × 5



1537

Double-walled glass cup Gerthe

Double-walled glass cup with 350ml capacity and bamboo lid, on which your logo will be engraved.

✂ ø 9,1 × 11 cm

☒ L3

☒ 5 × 5



ECO



GLASS, BAMBOO



150 ML



FOOD SAFE

2359

Bamboo Tray Formosa

Bamboo tray with bamboo spoon, borosilicate glass mug (150ml) and a slot for sugar or chocolate etc. Your logo will be engraved onto the board.

📏 16,4 × 8,1 × 8,4 cm

📦 L3

📦 3,5 × 2





GLASS



350 ML



DOUBLE WALLED



FOOD SAFE



3731

Double-walled cup Caracas

Double walled cup made of borosilicate glass with a filling capacity of 350ml. We print your logo on the cup by ceramic transfer. All-around printing possible on request.

➤ ø 8,5 × 10,5 cm

☒ C1

☒ 7 × 7



GLASS,
PLASTIC



400 ML



LEAKPROOF,
BPA FREE



FOOD SAFE



1535

Glass mug with lid Wattenscheid

Glass mug with leakproof lid and 400ml capacity. Your logo will be engraved on the cup.

➤ ø 8,6 × 15,7 cm

☒ C3

☒ 3 × 2



 CORK,
 PLASTIC

 350 ML

 LEAKPROOF,



 FOOD SAFE



2158

Leakproof mug Andenne

Leakproof drinking mug with cork coating, lockable mouthpiece and a capacity of 350 ml. Your Logo will be engraved onto the mug.

 ø 9 × 12 cm

 L3

 4 × 4

 ECO

 GLASS,
 SILICON,CORK

 350 ML



 FOOD SAFE



2665

Glass drinking cup Wroclaw

Drinking cup made of glass with a silicone lid, a cork sleeve and a capacity of 350ml. Your logo will be placed on the cuff.

 ø 9,7 × 12,3 cm

 L3

 2 × 2

GLASS,
STAINLESS STEEL

2 000 ML

FOOD SAFE



3577

Pitcher Puerto Rico

Glass pitcher with lockable stainless steel lid and strainer, solid handle and a capacity of 2,000 ml. Your logo will be engraved on the lid.

✂ \varnothing 13 x 23 cm
☒ L3
☒ \varnothing 5



GLASS

420 ML

FOOD SAFE



2905

Drinking glass Siena

Shapely drinking glass with a capacity of 420 ml. We will print your logo on the glass using a ceramic transfer.

✂ \varnothing 7,5 x 10,5 cm
☒ C3
☒ 5 x 5

GLASS

300 ML

FOOD SAFE



2906

Drinking glass Shanghai

Elegant drinking glass with a capacity of 300 ml. We will print your logo on the glass using a ceramic transfer.

✂ \varnothing 8 x 12,3 cm
☒ C3
☒ 5 x 5



GLASS, METAL,
PLASTIC

4 000 ML

5 PIECES,
STRAW

FOOD SAFE

0443

Glass dispenser with 4 jugs Braga

Glass dispenser (4,000ml) with 4 jugs (450ml) and 4 straws. This set is perfect for almost every season. Your logo will be laser engraved onto the screw top of the dispenser.

✂ 26 × 23,7 × 28,3 cm
 ☒ L3
 ☒ 4 × 3



GLASS, METAL

450 ML

WITHOUT STRAW

FOOD SAFE

0442

Glass jug

Glas jug (450 ml) with metal screw top, and straw hole (straw is not included). Your logo will be laser engraved on the screw top.

✂ 8 × 10,7 × 13 cm
 ☒ L3
 ☒ 3 × 1

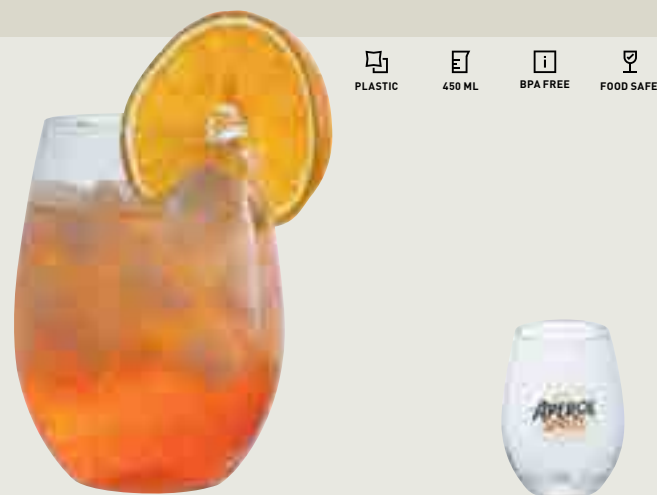

PLASTIC

450 ML

BPA FREE

FOOD SAFE

1456

Plastic glass St. Tropez

Nicely shaped drinking glass made of PET with a 450 ml filling capacity. Ideal for cocktails or long drinks. Your logo will be printed directly on the glass.

✂ ø 7,5 × 11 cm
 ☒ T4
 ☒ 3 × 3



PLASTIC

450 ML

BPA FREE

FOOD SAFE

03

06

1461

Champagne glass in plastic St. Moritz

Beach - garden - pool party, these glasses are indispensable and avoid injuries! Made of sturdy PS plastic, with a 450ml filling capacity. Your logo will be printed on the top.

✂ ø 8,5 × 22 cm
 ☒ T4
 ☒ 4 × 3

STAINLESS STEEL 170 ML LEAKPROOF FOOD SAFE



2439

Hip flask Hoogstraten

Stainless steel hip flask with wooden optic coating, safety screw mechanism and a capacity of 170 ml. Your logo will be printed on the surface.

✂ 9,5 × 2 × 9,5 cm
☒ T3
☒ 4 × 3



STAINLESS STEEL 104 ML LEAKPROOF FOOD SAFE



5708

Stainless steel hip flask Fresno

Cheers! Take a sip en route! Hip flask made of stainless steel with a safety twist cap and a capacity of 104 ml. The ideal present on which your logo will be laser engraved. Each hip flask is packed in a single cardboard box.

✂ 7 × 2,5 × 11,6 cm
☒ L3
☒ 4 × 4

STAINLESS STEEL 237 ML LEAKPROOF FOOD SAFE



5703

Stainless steel hip flask Kansas City

Take a sip whenever you want. A good Brandy is always delicious, especially in the cold season. Stainless steel hip flask with a safety twist cap and a capacity of 237 ml. The ideal present on which your logo will be laser engraved. Each hip flask is packed in a single cardboard box.

✂ 9,3 × 2,8 × 13,8 cm
☒ L3
☒ 5 × 5



STAINLESS STEEL

20 + 40 ML

FOOD SAFE



3237

bar measure Linz

Bar measure for exact dosing in two units, 2cl and 4cl made of stainless steel. Your logo will be engraved onto the bar measure.

- ✂ ø 4,3 × 8,2 cm
- ☒ L2
- ☒ 2,5 × 1,5



STAINLESS STEEL

FOOD SAFE

4021

Metal cocktail set, 3-piece Messina

Shaken, not stirred! With this high-quality chromed cocktail set you'll mix like a professional barman. The set contains 1 shaker, 1 measuring pitcher and 1 strainer with 2 supports. The strainer applies to the size of the glass thanks to its spiral, so that all bigger fruit or ice pieces are kept away from the glass when pouring. Rustproof stainless steel makes quality strainers indestructible. We will place your logo by means of laser engraving on the shaker. Each set is packed in a gift box.

- ✂ 27,2 × 24,1 × 9,3 cm
- ☒ L3
- ☒ 4 × 3

STAINLESS STEEL

170 ML

LEAKPROOF

FOOD SAFE



0168

Hipflask set with 2 cups

Beautiful set consisting of a hip flask (capacity 170 ml), two shot cups and a funnel, made of stainless steel. Your logo will be lasered on the hip flask.

- ✂ 18,8 × 17 × 4,4 cm
- ☒ L3
- ☒ 4 × 4



ECO

STAINLESS STEEL,
BAMBOO

FOOD SAFE



1.200 ML



3737

Ice Bucket Guatemala

Double-walled stainless steel ice bucket with carrying handle, bamboo lid, gripper and a filling capacity of 1,200 ml. Your logo will be laser engraved on the bucket.

➤ ø 13,8 × 14,7 cm

☒ L3

☒ 5 × 4



ECO



BAMBOO, GLASS



4 x 30 ML



FOOD SAFE



3228

shot glass set Kufstein

5-piece shot glass set with 4 glasses of 3cl each and a wooden board with a hand strap for transport. Your logo will be engraved onto the board.

➤ 33 × 8 × 6 cm

☒ L3

☒ 7 × 2



3088

Bottle opener Cologne

Classic bottle opener with a wooden handle. We engrave your logo on the wooden handle.

- ✂ 15 × 4,1 × 1,5 cm
- ☒ L2
- ☒ 5 × 1,5



2865

Waiter's knife Mendoza

Metal waiter's knife with bottle opener, foil cutter and corkscrew with 2 lifting levels. We will engrave your logo on the black surface.

- ✂ 11,9 × 1,4 × 2 cm
- ☒ L2
- ☒ 4 × 0,7

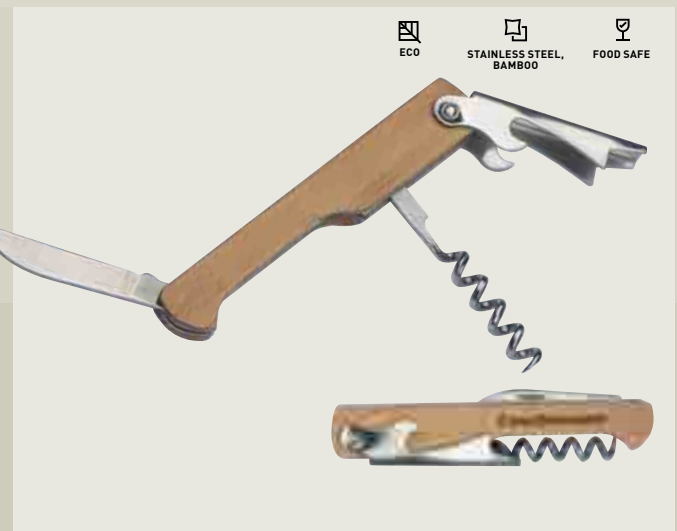

2456

Waiter's knife Miass

Metal waiter's knife with bamboo coating, bottle opener, foil cutter and corkscrew. We will engrave your logo on the coating.

- ✂ 11 × 1,2 × 2,5 cm
- ☒ L2
- ☒ 3 × 1





 ECO
 BAMBOO, METAL
 FOOD SAFE

3188

Wooden wine box saint-étienne

Wine box made of light wood with integrated waiter's knife, bottle stopper, pourer and drip ring in the lid. The additional wooden bracket holds the bottle securely in the box. Your logo will be engraved on the box.

 36 × 11,2 × 12,3 cm
 L3
 6 × 4





 ECO
 WOOD, METAL
 FOOD SAFE

4007

Wine box Jesolo

Stylish wine box equipped with a waiter's knife, a drip ring, a metal bottle stopper and a pourer with cap. Your logo will be placed on the lid bottom right preferably in gold.

 36 × 11,1 × 12,2 cm
 S2
 30 × 8

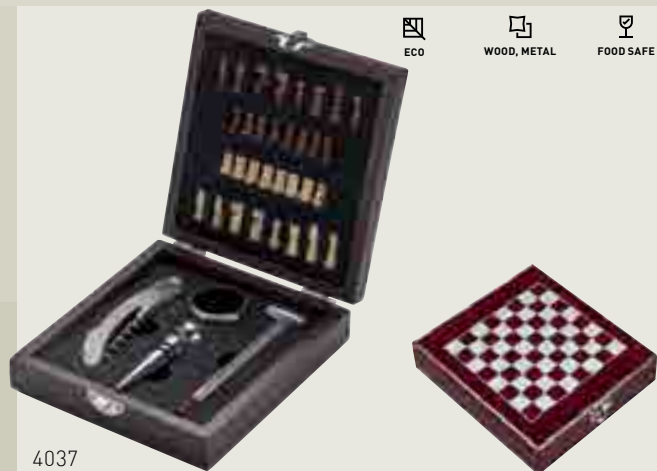



 ECO
 WOOD, METAL
 FOOD SAFE



4037

Chess wine set San Gimignano

Check! Enjoy a bottle of wine while contemplating your next move! This set contains all you need: waiter's knife (with corkscrew, bottle opener and a small blade), drop ring, metal bottle stopper and a thermometer all placed in a decorative wooden gift box. The chess pieces are neatly packed inside and the cover serves as a chess board. We will place your logo on the front of the wooden box preferably in silver. Each set is packed in a single cardboard box.

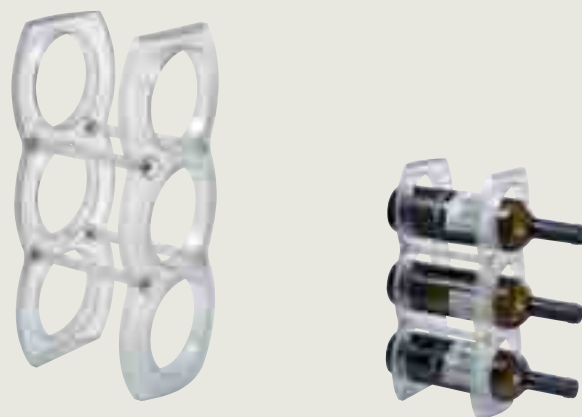
 15 × 17,5 × 4,7 cm
 S2
 10 × 1





 PLASTIC
 FOOD SAFE

8378

Plastic wine rack Elizabeth

This frosted plastic wine rack provides space for three bottles and fits even into the smallest flat thanks to its comfortable size; includes screws and instruction manual. We will print your logo on the rack.

 17 × 15,2 × 35,5 cm
 T4
 5 × 1





 ECO
  BAMBOO, METAL
  FOOD SAFE



1947

Wine set Grosseto

Wine set in a noble wooden box, consisting of a metal waiter's knife, bottle stopper, drop ring and wine thermometer. Your logo will be printed onto the box.

 22,8 × 12,8 × 4,6 cm
 L3
 5 × 3





 ECO
  WOOD

3732

Wine box Davenport

Wine box made of light wood with integrated carrying cord and sliding lid. The fixable wooden rail keeps the bottle securely stowed in the box. We engrave your logo on the outside.

 9,8 × 9,7 × 35 cm
 L3
 6 × 6



ECO



ORGANIC COTTON



LONG HANDLES



3219

Organic cotton bag Hong Kong

Oeko-Text® STANDARD 100 certified, organic cotton bag with a grammage of 220 g/m² and two long handles. We print your logo in the centre of the bag on one side.

- ✂ 38 × 0,2 × 42 cm
- ✂ ST
- 📏 26 × 27



ECO



ORGANIC COTTON



LONG HANDLES



3222

Organic cotton bag with bottom fold Innsbruck

Oeko-Text® STANDARD 100 certified, organic cotton bag with a grammage of 180 g/m² and two long handles. It offers a lot of space due to the large bottom gusset. We print your logo in the centre of the bag on one side.

- ✂ 38 × 10,5 × 42 cm
- ✂ ST
- 📏 26 × 27



ORGANIC COTTON

Organic cotton is grown without synthetic chemicals or pesticides, using methods that promote biodiversity and lower environmental impact. It relies on natural processes like crop rotation and composting to maintain soil fertility and control pests. By avoiding harmful chemicals, organic cotton protects farmers, consumers, and the ecosystem. Its cultivation also reduces water consumption and pollution, making it a sustainable choice. Consumers opting for organic cotton support fair trade practices, ensuring farmers receive fair wages and work in safe conditions. Overall, organic cotton is an eco-friendly and ethical alternative, contributing to a greener and healthier textile industry.



ECO ORGANIC COTTON LONG HANDLES

ECO ORGANIC COTTON LONG HANDLES



03



13



3221

Organic cotton shopping bag Imola

Oeko-Tex® STANDARD 100 certified, organic cotton bag with a grammage of 180 g/m², two long handles and drawstring closure. We print your logo in the centre of the bag on one side.

✂ 53 × 0,5 × 37 cm

✂ ST

📏 26 × 27



06



03



44



3229

Organic cotton bag Bari

Extra large and sturdy Oeko-Tex® STANDARD 100 certified bag made of organic cotton with a grammage of 270 g/m², two long handles and a bottom gusset. We will print your logo in the middle of one side of the bag

✂ 57 × 9 × 36,5 cm

✂ ST2

📏 26 × 27



ECO



COTTON



LONG HANDLES,
FOLDABLE



1411

Foldable cotton bag Kleholm

Nature-colored foldable shopping bag with handles. Your logo is printed on one side.

- ✂ 38 × 0,3 × 42,5 cm
- ✂ ST
- ✂ 26 × 27

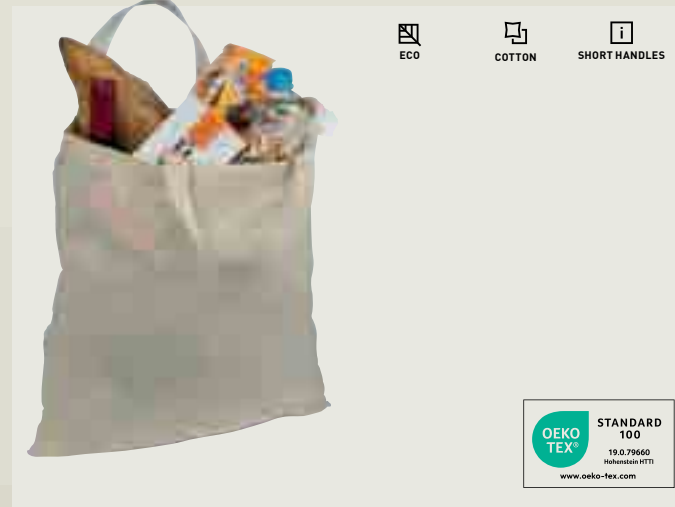

ECO



COTTON



SHORT HANDLES



2547

Cotton bag Arrecife

Made of 140 g/m² OEKO-TEX material, natural colour, 100% cotton bag with two short handles. These good quality eco friendly cotton bags can be used over and over again and they are washable.

- ✂ 38 × 0,3 × 41 cm
- ✂ ST
- ✂ 26 × 27



ECO



COTTON



SHORT HANDLES,
FOLDABLE



0859

Foldable shopping bag Ferrara

Natural colored, foldable and environmentally-friendly cotton bag [120g/m²] with carrying handle. We print your logo on one side.

- ✂ 37,5 × 0,3 × 42 cm
- ✂ ST
- ✂ 26 × 27

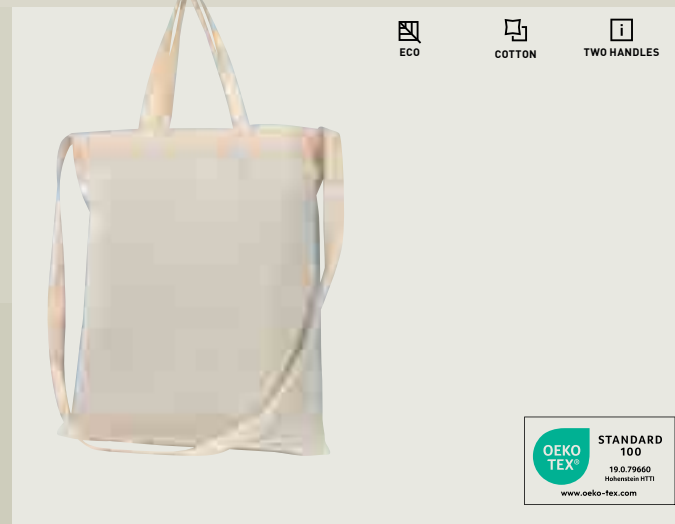

ECO



COTTON



TWO HANDLES



1369

Cotton bag with 3 handles Nordkoog

Nature-colored, environmentally friendly cotton bag with two short handles and one long carrying strap. We will print your logo on one side.

- ✂ 38 × 0,3 × 41,7 cm
- ✂ ST
- ✂ 26 × 27



OEKO-TEX

To achieve Oeko-Tex certification, textile products must comply with restrictions on harmful substances, including chemicals such as formaldehyde, azobenzene, chlorinated chemicals, etc. These substances are checked based on ecological and toxicological tests.

Oeko-Tex standards cover the entire production process, including textile materials, fabrics, and finished products. Oeko-Tex certification ensures that the end product is safe for human health and does not contribute to environmental harm.



ECO



COTTON



LONG HANDLES



2164

Cotton bag Manacor

Oeko-Tex® STANDARD 100 certified, cotton bag with a grammage of 140 g/m² and two long handles. We print your logo in the centre of the bag.

✂ 37 × 0,2 × 41 cm

☒ ST

☒ 26 × 27



ECO COTTON LONG HANDLE

3465

Cotton bag Loja

Shopping classic! Nature coloured cotton bag with one long handle. The sturdy material, of course washable, makes it a permanent companion for your customer. There is enough space on the large front for your logo, which we will print in screen printing. Every additional colour 50% of the following printing price. Set-up costs are per colour.

- ✂ 38 × 0,2 × 41 cm
- ☒ ST
- ☒ 26 × 27



ECO COTTON LONG HANDLE

1487

Cotton bag with canvas belt Lehbek

Large, environmentally friendly, natural-colored cotton bag with woven handles and bottom crease. Your logo will be printed on one side.

- ✂ 40,5 × 6 × 42 cm
- ☒ ST
- ☒ 26 × 27



ECO COTTON SHORT HANDLES

3464

Cotton bag Antibes

Shopping classic for your small purchase. Nature coloured cotton bag with two short handles. The sturdy material, of course washable, makes it a permanent companion for your customer. There is enough space on the front for your logo, which we will print in screen printing. Every additional colour 50% of the following printing price. Set-up costs are per colour.

- ✂ 28 × 0,2 × 32 cm
- ☒ ST
- ☒ 20 × 20



ECO COTTON SHORT HANDLES

1486

Mini cotton bag Bordelum

Small pharmacy bag made of natural-colored cotton. Your logo will be printed on one side.

- ✂ 22 × 0,3 × 26,3 cm
- ☒ ST
- ☒ 14 × 14





ECO COTTON SHORT HANDLES



2680

Cotton wine bag Nice

Oeko-Tex® STANDARD 100 certified cotton gift bag for bottles. It is perfect for giving gifts of this kind in a sustainable manner. We will print your logo on the bag.

- ✂ 16,9 × 8,5 × 27,2 cm
- ✂ TT1
- ☒ 8 × 12



ECO COTTON LONG HANDLES



1831

Cotton Bag Alanya

Eco Tex Standard 100 Cotton Bag with crocheted middle section which makes the bag flexible. Your Logo will be printed on one side of the bag.

- ✂ 20,2 × 14,5 × 29,5 cm
- ✂ ST
- ☒ 13 × 8



ECO COTTON



1477

Cotton sack Baguette

Bread bag made of environmentally friendly cotton with drawstring for closing. Your logo will be printed on one side.

- ✂ 30 × 0,3 × 49,5 cm
- ✂ ST
- ☒ 18 × 25



 ECO
 COTTON
 LONG HANDLES



0880

Cotton bag Copenhagen

Eco-friendly cotton bag with long handles, in different colors and a particularly strong grammage of 140g/m². Your logo will be printed on one side.

-  38 × 0,3 × 42 cm
-  ST2
-  26 × 27



 ECO
 COTTON
 SHORT HANDLES



0680

Cotton bag Bregenz

Cotton bag (grammage 140 g / m) with short handles. We will print your logo on one side.

-  42 × 38 cm
-  ST2
-  26 × 27



RECYCLED COTTON

Recycled cotton, also known as reclaimed cotton, offers a sustainable alternative to traditional cotton. It is created from post-consumer and post-industrial cotton waste, eliminating the need for new raw materials. Recycling cotton reduces water and energy consumption while minimizing environmental impact. Choosing recycled cotton products contributes to a greener and more responsible fashion industry, supporting a circular approach to reduce textile waste and conserve resources.



ECO
RECYCLED COTTON
LONG HANDLES



03



04



05



06



2358

Recycled Cotton Bag Chelmsford

Recycled Eco Tex Standard 100 Cotton Bag with long Handles (140g/m²).
Your logo will be printed on one side of the bag.

- ✂ 37,6 × 0,2 × 41,7 cm
- 🧺 ST2
- 📏 26 × 27

ECO
ORGANIC COTTON
LONG HANDLES





03



04



05



06



09



10



14



24



44



3706

Organic Cotton Bag Barnsley

Certified Oeko-Tex® STANDARD 100, organic cotton bag with a grammage of 180 g/m² and two long handles. We print your logo in the centre of one side of the bag.

- ✂ 37,5 × 0,3 × 42 cm
- 🧺 ST2
- 📏 26 × 27



NON-WOVEN



SHORT HANDLES



04



05



08



10



13



8392

Non woven bag Nivala

Why pay more? This sturdy non woven bag is the perfect shopper bag and fits into every budget. The bag offers big space for your customers logo. We will silk screen your logo onto the middle of the bag.

- ✂ 38 x 0,3 x 42 cm
- ☒ S1
- ☒ 25 x 25



NON-WOVEN



LONG HANDLES



04



05



09



0913

Bag Erlangen

Non-woven bag with extra long handles. We print your logo centered on the bag.

- ✂ 33 x 0,3 x 39 cm
- ☒ S1
- ☒ 20 x 20



NON-WOVEN



LONG HANDLES



0094

Non-woven shopping bag

Foldable non-woven shopping bag in a nice 2-colour design with carrying handles. We will print your logo onto the front.

- ✂ 37 x 10,8 x 30,2 cm
- ☒ S1
- ☒ 25 x 15



04

05

06

08

09

10

11



 **NON-WOVEN**  **LONG HANDLES**



3651

Non-woven Bag San Miguel

Non-woven bag with 80gsm and long handles. Your logo will be printed on one side.

 35,5 × 0,3 × 40 cm
 S1
 20 × 20



 **NON-WOVEN**  **SHORT HANDLES, FOLDABLE**



3654

Non-woven Bag San Bernardino

Foldable non woven bag with 80gsm and short handles. Your logo will be printed on one side.

 21 × 2 × 13 cm
 S1
 10 × 10



 **NON-WOVEN**  **LONG HANDLES**





3652

Non-woven Bag San Rafael

Large non-woven bag with 80gsm, bottom gusset and long handles. Your logo will be printed on one side.

 41,5 × 11 × 35 cm
 S1
 20 × 20



 **NON-WOVEN**  **LONG HANDLES**



3653

Non-woven Bag San Angelo

Non-woven bag with 80gsm and long handles. Your logo will be printed on one side.

 25 × 11 × 36 cm
 S1
 20 × 20



ECO



COTTON,
SYNTHETIC JUTE



LONG HANDLES



3632

Beach bag Sao Luís

Eco-friendly beach bag made of cotton and jute with long handles. Everything for your beach trip fits in here. Your logo will be printed on one side.

✂ 45,7 × 15 × 34 cm

✂ ST

✂ 26 × 20



ECO



JUTE



SHORT HANDLES



7528

Jute bag, big Hannover

The Eco-friendly long life shoppers. This bag is made of biodegradable jute (which is well known for its durability) so not only does it look good but its also kind to the environment. Your logo will be printed to one side of this bag.

✂ 44 × 19 × 37 cm

✂ TT3

✂ 20 × 10



ECO



JUTE



LONG HANDLES



7536

Jute bag Kastamonu

Jute bag with robust cord grips and a closing loop. We will print your logo on the front.

✂ 44,7 × 12,5 × 35,5 cm

✂ TT3

✂ 20 × 10



ECO RECYCLED COTTON

13



77



2981

Recycled cotton bag Pasadena

Oeko-Tex® STANDARD 100 certified, recycled, environmentally friendly cotton bag with a grammage of 110g / m². Your logo will be printed on one side.

- ✂ 25 × 0,2 × 32 cm
- ☒ S1
- ☒ 20 × 20



ECO RECYCLED COTTON

13



77



2982

Recycled cotton bag Parkville

Oeko-Tex® STANDARD 100 certified, recycled, environmentally friendly cotton bag with a grammage of 110g / m². Your logo will be printed on one side.

- ✂ 30 × 0,2 × 46 cm
- ☒ S1
- ☒ 26 × 27



ECO LAMINATED PAPER LONG HANDLES



2423

Paper bag Grand Rapids

Robust shopping bag with long handles, padded inside and paper lining outside, durable and environmentally friendly. Your logo will be printed on one side.

- ✂ 37,5 × 0,3 × 32 cm
- ☒ S1
- ☒ 20 × 20



ECO FELT LONG HANDLES



1373

Felt bag Trieste

Modern felt bag with 2 long handles and snap fastener. Your logo will be printed on the bag; laser engraving on request.

- ✂ 46 × 10 × 40 cm
- ☒ TT3
- ☒ 20 × 15



 210D POLYESTER
  SHORT HANDLES, FOLDABLE



0724

Foldable shopping bag

190T polyester foldable shopping bag, with carrying straps. We will print your logo directly on the bag.

 37,5 × 0,3 × 48 cm

 S1

 23 × 20

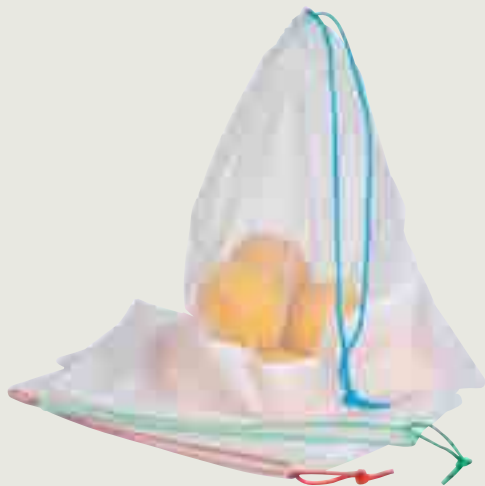

 PET, POLYESTER
  SET OF 3

2983

Fresh net, set of 3 Miami

The perfect sustainable shopping companion not only for fruit and vegetables. The set of 3 consists of PET (net part) and the lower third of 210D polyester. We print your logo in the lower third on the polyester part.

 25 × 0,2 × 30,5 cm

 S1

 18 × 6





NON-WOVEN

FOLDABLE



0568

Trunk bag Bergen

Non-Woven foldable bag for the trunk. When folded, a great space-saver; when unfolded, the perfect space for all your purchases. We print your logo on one side.

- ✂ 54 × 32 × 32 cm
- ✂ TT3
- ✂ 15 × 10



05



44



77

600D POLYESTER

ISOLATING COLLAPSIBLE



0059

Shopping basket with cooling function Laval

Shopping basket with aluminum frame and large cooling compartment. We print your logo on one side.

- ✂ 47,5 × 27 × 38 cm
- ✂ TT3
- ✂ 15 × 8



05



44



77

600D POLYESTER

COLLAPSIBLE



0058

Shopping basket Baden-Baden

Shopping basket with aluminum frame in different colors, your shopping made easy. We print your logo on one side,

- ✂ 47,5 × 27 × 37 cm
- ✂ TT3
- ✂ 15 × 8



ECO



COTTON



03

04

05

08

09



0920

Cotton bag Londonderry

Classic gymbag made of cotton with extra thick drawstrings. We print your logo on one side of the bag.

✂ 39 × 0,3 × 41,5 cm

✂ ST

✂ 26 × 27



ECO



COTTON



3466

Cotton bag Suva

Not only for shopping. This nature coloured cotton bag offers many possibilities for use. Whether as backpack, clothes bag, etc., it is the perfect environmental-friendly companion. Due to the long-life material, of course washable, you will always be present with your logo. The large front offers enough space for your logo, which we will print in screen printing. Any further colour 50% of the following printing price. Set-up costs are per colour.

✂ 37,5 × 0,3 × 46 cm

✂ ST

✂ 26 × 27



ECO



COTTON



0661

Cotton duffel bag

Natural, eco-friendly cotton duffel bag with drawstrings, which also work as shoulder strap. We will print your logo on one side.

✂ ø 24 × 44 cm

✂ ST

✂ 14 × 14



0026

Cotton gymbag Carlsbad

Gymbag made of cotton (grammage 140g / m²). Ideal for sports equipment or for on the go. This will make you a constant companion. We will print your logo on one side.

- ✂ 26 × 45 × 0,2 cm
- ✂ ST2
- 📏 26 × 27



0024

Cotton gymbag Budapest

Gymbag made of cotton (grammage 140g / m²). Ideal for sports equipment or for on the go. This will make you a constant companion. We will print your logo on one side.

- ✂ 37 × 44 × 0,2 cm
- ✂ ST2
- 📏 26 × 27



2543

Recycled Cotton Bag Addison

Oeko-Tex® STANDARD 100 certified, recycled cotton bag with long carrying handles, additional carrying cords and a grammage of 140g/m². The logo is printed on one side of the bag.

- ✂ 37,5 × 0,3 × 42 cm
- ✂ ST2
- 📏 26 × 27







NON-WOVEN



0861

Non-woven sports bag Seoul

Sports bag in polyester, works as a gym or laundry bag; the drawstring also works as a carrying strap. We print your logo on one side.

 37 × 40,5 cm
 S1
 19 × 19





190T POLYESTER



8515

Sports bag Leopoldsborg

Sports bag made of 190T polyester. We print your logo on the front.

 32,5 × 0,3 × 43 cm
 S1
 24 × 24

300D SNOW-POLYESTER



0713

Sports bag Mexico City

Non-woven sports bag with front compartment where we will print your logo. You will find enough space for your sports equipment.

- ✂ 33 × 40,5 × 0,1 cm
- ☒ TT2
- ☒ 15 × 10

NON-WOVEN REFLECTIVE



0994

Reflector Draw String Bag Bochum

Draw string bag made of non woven with a reflective strip. Your logo will be printed on the black part underpart.

- ✂ 35 × 0,4 × 44,5 cm
- ☒ S1
- ☒ 19 × 19

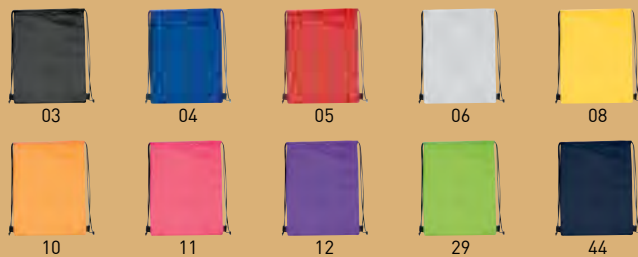

210D POLYESTER ISOLATING



0649

Polyester gym bag

Sports bag made of 210D polyester with insulating lining and drawstring. Sports bag, cooler bag, seat cushion, promo bag, The advertising imprint is on one side.

- ✂ 31,7 × 1 × 42,5 cm
- ☒ S1
- ☒ 20 × 24





 70D POLYESTER

 ISOLATING



04

05

06

99

7004

Cool bag 6 x 0.33 l Aspen

Keep your drinks cool with this handy nylon cooler bag with a practical carrying strap and zipper. Provides space for six 0,33 l cans. We will put your logo on the front.

 20 x 13 x 12,5 cm

 S1

 10 x 5



 70D POLYESTER

 ISOLATING



04

05

06

7104

Cool bag Mesa

Nicely cold drinks with this handy nylon cooler bag with a practical carrying strap and zipper. Provides space for 6 big 0,5l cans or 6 small bottles per 0,5l. We will put your logo on the front.

 20,5 x 17 x 14,5 cm

 S1

 10 x 5



 70D POLYESTER

 ISOLATING



03

04

05

07

2472

Cooling bag San Juan

Polyester cooling bag with insulating foil inside and velcro fastener. Your logo will be printed on one side.

 18 x 12 x 27 cm

 S1

 10 x 12



NON-WOVEN ISOLATING

3818

Cooler Bag Plzeň

Lined cooler bag made of non-woven with aluminium coating inside, velcro closure and two carrying handles. We print your logo on the front of the bag.
 ✂ 23 x 13 x 28 cm
 ☒ TT1
 ☒ 10 x 10



NON-WOVEN ISOLATING

1542

Non woven cooling bag Nieby

Non-woven cooling bag with carrying strap, suitable for 6 standing beverage cans (0.33 litres.) Your logo will be printed on the lid.
 ✂ 21 x 15,5 x 15 cm
 ☒ S1
 ☒ 10 x 5



600D POLYESTER ISOLATING

04



05



2897

Can shaped cooler bag Caldera

That's cool! This chic and sturdy 600D polyester cooler bag offers besides the big cooling compartment, two mesh pockets and a small pocket. The bag is really comfy to carry because of the adjustable shoulder strap. We will print your logo onto the middle of the bag. single-packed in poly bag.

- ✂ @ 21,7 × 26,5 cm
- ☒ TT2
- ☒ 12 × 8



POLYESTER, PVC ISOLATING, LONG HANDLES

10



29



0074

Multifunctional bag Cork

Multifunctional bag with transparent handles. Ideal as a cooling bag because of the isolation or chair pillow. We will print your logo on one side.

- ✂ 42 × 15,5 × 35 cm
- ☒ S2
- ☒ 20 × 15



NON-WOVEN ISOLATING, LONG HANDLES

0708

Cooler Bag Vancouver

Non-woven cooler bag with two carrying straps and two-coloured design. We will print your logo on the front.

- ✂ 38,5 × 16 × 35 cm
- ☒ TT2
- ☒ 15 × 8



04

05

77





600D POLYESTER ISOLATING



3126

Backpack with cooling function Clarksville

Stylish backpack made of robust 600D polyester with a separate cooling compartment. With the adjustable click fastener at the top, the size of the backpack can be individually adjusted to the filling. It also has a front compartment with zipper, two mesh compartments on the outside (one on the right and one on the left) and adjustable padded shoulder straps. We will print your logo on the flap of the cooling compartment.

- ✂ 30 × 12 × 46 cm
- ☒ S1
- ☒ 16 × 12



420D POLYESTER ISOLATING



3640

Cooler bag Sao Carlos

420D polyester cooler bag with seam design, front compartment, carrying strap and two handles. Your logo will be printed on the front compartment.

- ✂ 32 × 14 × 38 cm
- ☒ S2
- ☒ 15 × 15



ECO



RECYCLED PET



ISOLATING



2978

RPET cooler bag Perth

RPET cooler bag with 2 separate PEVA cooler compartments and a front pocket. Thanks to the shoulder strap, the cooler bag is perfect for all situations, whether shopping, a day at the beach or on vacation. We will print your logo on the bag.

- ✂ 31,5 × 20 × 23 cm
- ☒ S1
- ☒ 10 × 5



POLYESTER, GLASS



1 000 ML

GLASS CONTAINER
INCLUDED,
ISOLATING

2977

Cooler bag Montpellier

The ideal companion not only for the lunch break. This two-part polyester cooler bag has a precisely fitting glass lunch box (1.000 ml) in its lower compartment. Thanks to the insulation of the bag, the food can be kept warm for longer and not just cooled. We'll print your logo on the top.

- ✂ 21 × 16 × 16 cm
- ☒ TT1
- ☒ 10 × 5

600D POLYESTER,
CERAMIC,
STAINLESS STEEL,
PLASTICFOR 4 PERSONS,
ISOLATING

2975

Picnic bag Mumbai

Picnic bag for 4 people with handle and shoulder strap. There is also a cooling compartment in the picnic bag, which cools your food and drinks even on warm days. Plates and cutlery for 4 people. We'll print your logo on the bag.

- ✂ 36 × 33 × 28 cm
- ☒ TT3
- ☒ 15 × 8



PLASTIC



8721

Thermal pack Arktis

Extra cool! This useful plastic thermal pack(170 ml) keeps your beverage and food cool for an extra long time in your cooler bags. Just put the plastic pack filled with cooling liquid into the fridge for a couple of hours and yet it is ready to use. We will print your logo centered on the back. Single packed in poly bag.

- ✂ 6,5 × 2,8 × 10,4 cm
- ☒ T3
- ☑ 3,5 × 2,5



300D + 600D
POLYESTER



ISOLATING



0714

Cooler bag Elmont

300D+600D polyester cooler bag with carrying handle, zipper closure, space for six 500ml cans or bottles and a front compartment printed with your logo.

- ✂ 27 × 21 × 15,5 cm
- ☒ TT2
- ☑ 10 × 8



300D SNOW-
POLYESTER



0713

Sports bag Mexico City

Non-woven sports bag with front compartment where we will print your logo. You will find enough space for your sports equipment.

- ✂ 33 × 40,5 × 0,1 cm
- ☒ TT2
- ☑ 15 × 10



600D SNOW-
POLYESTER



LAPTOP
COMPARTMENT



1483

Laptop bag Dudley

High-quality, padded laptop backpack with interior compartments and zipper. We print your logo on the front.

- ✂ 28 × 11,5 × 45 cm
- ☒ TT2
- ☑ 15 × 10





 500D POLYESTER





 ANTI-THEFT COMPARTMENT



3659

Backpack Salzburg

Backpack made of 500D polyester with foldable or rollable closure, padded straps, carrying handle and lockable front compartment. Your logo will be printed on the front compartment.

-  30 x 13 x 40 cm
-  TT2
-  20 x 15



-  ECO
-  RECYCLED PET
-  LAPTOP AND ANTI-THEFT COMPARTMENT
-  USB-A PORT

3660

rPET backpack Rimini

rPET backpack with USB port, padded straps, laptop compartment, front compartment and anti-theft compartment. We print your logo on the front compartment.

 29 × 15 × 47 cm

 TT2

 20 × 15



ECO



RECYCLED PET



LAPTOP COMPARTMENT



3790

RPET Backpack Oklahoma City

Backpack made from recycled PET. In addition to a large inner compartment with laptop sleeve, padded back, carrying handle, two adjustable padded shoulder straps, zipped front compartment, adjustable closure, Velcro closure on the top, it also has two side pockets on the outside. We will print your logo in the centre front.

✂ 35 × 13 × 42 cm

🗑 S2

📏 20 × 20



03



06



600D POLYESTER



LAPTOP COMPARTMENT



1377

Laptop bag Chesterfield

Laptop backpack in new attractive design, with several inner compartments and two outer compartments. Your logo will be printed centred on the front.

✂ 28,5 × 15 × 40 cm

🗑 TT2

📏 15 × 10



 1200D NYLON

 LAPTOP COMPARTMENT 15.6" TROLLEY COMPATIBLE



 WATERPROOF, REFLECTING



2535

Laptop backpack Modica

Waterproof, trolley-compatible laptop backpack made of 1200D nylon for 15.6" laptops with reflective zips, large carrying capacity, various compartments and reflective safety strip on the front. Your logo is printed on the front.

-  32 x 14 x 44 cm
-  S1
-  15 x 10

 600D POLYESTER

 LAPTOP AND ANTI-THEFT COMPARTMENT



 USB-A



3248

Backpack Wellington

Trolley ready anti-theft hard shell backpack made of 600D polyester with extra features: Combination lock for the main compartment, anti-theft compartment on the back, small zippered compartment on the padded shoulder strap, padded back panel, padded carry handle, laptop compartment with front pocket and elastic straps, a USB port for connecting a powerbank (not included), four pen loops, opening for headphones, three slip pockets and a removable key ring. With two velcro closures inside, the backpack can be opened either partially or fully. Your logo will be placed on the front.

-  33 x 13 x 45 cm
-  S2
-  15 x 15



3721

RPET Felt Backpack Birmingham

High-quality backpack made of recycled felt. In addition to the roomy inner compartment with adjustable closure, it has a zipped front compartment and adjustable padded shoulder straps. Your logo will be placed on the front compartment.

- ✂ 33 × 12 × 53 cm
- ☒ TT2
- ☒ 15 × 10



3755

RPET Laptop Bag Lugano

Spacey laptop bag made of felt (recycled PET, 370 gsm) with zip and padded handle. We print your logo in the centre front.

- ✂ 38 × 8 × 30 cm
- ☒ TT2
- ☒ 25 × 15





04

05

08

09

10

0055

Laptop bag Ferrol

Gray laptop bag with bright colored accents, spacious interior compartment, and front compartment, on which we will print your logo.

✂ 38 × 31,5 × 5 cm

✂ TT2

📏 20 × 10

📏 600D POLYESTER

📏 LAPTOP COMPARTMENT



📏 ECO

♻️ RECYCLED PET

📏 LAPTOP COMPARTMENT



3772

RPET laptop bag Minsk

Laptop bag made of 600D recycled PET. The bag has a detachable and adjustable shoulder strap with movable padding, two carrying handles, an additional pocket inside and a zipped front compartment. We print your logo on the front compartment.

✂ 39 × 6 × 30 cm

✂ TT2

📏 15 × 10

600D POLYESTER



03



04



05



08





10



4191

City bag Córdoba

This trendy one-shoulder city bag is made of robust polyester everyone likes to wear them! It features a spacious main compartment along with a mobile phone compartment for fast access to your mobile phone. It also features two further zipper compartments. We will place your logo underneath the second zipper compartment.

 26 x 16 x 50 cm
 TT2
 10 x 10

600D POLYESTER



05





06



0696

Backpack Derry

Backpack made of 600D polyester with large inner compartment, front pocket, padded shoulder straps and padded back for high wearing comfort. We print your logo on the left side of the zipper.

 23 x 40 x 9 cm
 TT2
 10 x 8

600D POLYESTER



03



04



05



08





10



4170

Trendy backpack Cadiz

A backpack that fulfils all needs and is suitable for all. It is made of robust polyester and features a large main compartment in addition to a sufficiently big front compartment. It also features well padded shoulder straps. There are endless uses for this item. We will place your logo on the front compartment.

 29 x 16 x 38 cm
 TT2
 12 x 8

600D POLYESTER





TOP PRICE



0075

Backpack Fashion

Longlasting backpack made of 600D polyester in gaudy colours with a big main compartment and an extra front compartment. Your logo will be printed on the front compartment.

 29 x 13 x 40 cm
 TT2
 20 x 10



ECO



RECYCLED PET



FOLDABLE



3592

Foldable backpack Stockton

Foldable, lightweight backpack made of 420 D RPET (recycled PET) with small zippered front compartment and adjustable shoulder straps. The additional compartment sewn on the top also serves as a case for the folded backpack. So it can be stored space-saving and is always at hand. We print your logo on the backpack.

- ✂ 29 × 54 × 10 cm
- ☒ S2
- ☒ 20 × 7



600D POLYESTER



REFLECTIVE



2350

Waist Bag Cosenza

Reflecting Waist Bag made from Polyester with an adjustable strap and a big compartment. Your logo will be printed on the bag.

- ✂ 34 × 7 × 12,5 cm
- ☒ S1
- ☒ 12 × 6



500D PVC



WATERPROOF,
BACKPACK-FUNCTION,
REFLECTIVE



1516

Waterproof bag Malmedy

Neon-colored, waterproof closable bag with 2 adjustable shoulder straps. So the bag can be carried as a shoulder bag or backpack. Leader with reflective stripes. Your logo will be printed on the bag.

- ✂ ø 23 × 50 cm
- ☒ S1
- ☒ 15 × 10



600D POLYESTER



04



05



06



77



0697

Belt bag Caravelas

Belt bag in 600D polyester with zipped compartment, slide-in compartment, and adjustable shoulder strap. The logo is printed on the front center of the bag

- ✂ 35,5 × 5,5 × 15 cm
- ☒ TT1
- ☒ 8 × 5

600D POLYESTER



04

05

07

08

10

2061

Sports travel bag Palma

Trendy and fancy. This sports bag will captivate with its design. There are various trendy colours available that will appeal to everyone. It features a large main compartment, a front compartment, a padded belt, which is also adjustable and removable, as well as the comfortable strap which means that it is easy to carry the bag without cutting in your shoulders. Due to its rugged 600D polyester the bag is also very resilient. We will print your logo on the front compartment.

✂ 61 × 28 × 32 cm

☒ TT3

☒ 15 × 10

600D POLYESTER



0056

Sports bag Gaspar

Large 600D polyester sports bag with large inner compartment, carrying handles, and adjustable shoulder strap. We print your logo on one side.

✂ 52 × 26 × 23 cm

☒ TT3

☒ 12 × 12



04

05

08

09

10



44



77



ECO



RECYCLED PET

3723

RPET Bag Bologna

Bag made of recycled 300D polyester. The perfect companion whether for sports or travel. In addition to the spacious inner compartment, the bag has an adjustable and removable shoulder strap, two carrying handles, two mesh pockets on the outside and a zipper compartment on the outside. We will print your logo on the zipper compartment.

✂ 54 × 20 × 25 cm

✂ TT3

✂ 20 × 10





ABS, METAL,
POLYESTER

ON BOARD SIZE,
TSA-LOCK



0907

Trolley Esprit

Resistant travel trolley with different inner compartments and carry-on size. We will print your logo on a label.

✂ 39,5 × 22 × 56,5 cm
 ✂ L3
 ☑ 4 × 1

PEVA



3962

Suit cover Gijón

Ideal for travel! With this practical suit cover made of rugged PEVA material with a zipper and a viewing window your suits will stay wrinkle free when travelling. We will print your logo onto a label.

✂ 100 × 57,5 cm
 ✂ ETN1
 ☑ 6 × 3

600D POLYESTER



3801

Suit bag Santander

With this practical suit bag made of high quality 600D polyester with many zipper compartments as well as a removable shoulder strap, your suits will remain wrinkle free when travelling. Just fold it over and take it with you as a bag! For your convenience, in the upper part there is an integrated firm hook, so that you can hang the suit bag. You can fit everything that you need for the journey into this bag.

✂ 110 × 60 × 8 cm
 ✂ L3
 ☑ 4,5 × 0,8

FELT



3799

Felt Suitcase Tag Portland

Felt luggage tag with adjustable fastening and a hinged cover over the address field. We print your logo on one side.

- ✂ 17,5 × 5,9 × 0,4 cm
- 📏 L2
- 📦 4 × 2

PVC



2576

PVC document cover Marseille

Transparent, flexible PVC cover for travel, vaccination or other documents. Protects against dirt and wear. Your logo will be printed on the outside of the cover.

- ✂ 13,8 × 9,9 × 0,2 cm
- 📏 T2
- 📦 4 × 3



POLYESTER, ABS



1344

Adjustable luggage strap Moordeich

Adjustable polyester luggage strap with plastic closure.

- ✂ 193 × 6 cm
- 📏 S3
- 📦 38 × 3



NON-WOVEN



FOLDABLE



8234

Non-woven seat cushion Manchester

Comfortable! This seat cushion made of non-woven material (75 gsm) is the ideal companion. It can be used in the stadium, at picnic, etc. With this cushion you will always sit comfortably and protected from cold. The folding principle and the rubber band makes it easy for transport. We will print your logo on one segment.

- ✂ 34,5 × 32 × 1 cm
- ☒ TT2
- ☒ 20 × 5



PVC



03



05



07



44

3125

Neck pillow Orléans

Lean back! Blow-up neck pillow in velour design in a practical pouch. Ideal to ensure relaxed travel whether by car, bus or plane. Packed in a single velour pouch. We will place your logo on one side of the neck pillow.

- ✂ 34 × 25 × 10 cm
- ☒ TT1
- ☒ 6 × 3



03



06



ABS



1769

Bag holder for trolleys Armant

This item facilitates to hook a bag on your trolley. Just add it onto the handle of a trolley and hang your bag on it. We will pad print your logo onto the hook.

- ✂ 3,6 × 3,6 × 7,8 cm
- ☒ T2
- ☒ 2,5 × 3



METAL



8659

Handbag holder Rose Hill

A perfect accessory for every woman! Keep your handbags off the dirty ground with the elegant handbag holder. We suggest to laser engrave your logo onto the silver circular design. Single packed in a cardboard box.

- ✂ ø 4,5 × 0,8 cm
- ☒ L2
- ☒ ø 2,5





 RUBBER, KNIT  500 ML

1618

Hot-water bottle Kalibo

For warm moments on cold winter days! This cuddly hot-water bottle has a capacity of approx. 550 ml and is very comfortable due to its knit cover. Comes in a poly bag. We will print your logo in the middle of the knit cover.

 15 x 5 x 26 cm
 TT2
 10 x 8





 METAL
190D NYLON

0138

Toilet bag Charlestown

190T nylon toilet bag with a large inner compartment, 3 zipped compartments, 4 elastic bands, and hanging hook. We print your logo on the front.

 25,5 x 14,5 x 11 cm
 S1
 10 x 5





 METAL
70D POLYESTER

2011

Toilet bag La Rochelle

Our toilet bag recommendation! This is the right one! Made of robust nylon - inside with ample space, there is a transparent zipper compartment, a stretch band with 5 loops, 3 big net compartments and 2 net compartments with a metal hook, which you can take out by means of a Velcro fastener, for hanging up in the shower for e.g. shampoo or shower gel. The bag provides a 270 degrees surround zipper and one further metal hook for hanging it up. This is practical and convenient! We will print your logo on the front of the bag.

 20 x 7 x 25 cm
 S1
 10 x 5



PU



6 PIECES



3231

Shoe polish roll Grenoble

Leatherette shoe polish roll with transparent shoe polish, sponge, shoe brush, shoe spoon, polishing cloth and cream applicator. We print your logo on the case.

➤ ø 7,2 × 16,7 cm

☒ T4

☒ 5 × 2



METAL, POLYESTER



8 PIECES



3212

Shoe polish set Cannes

Shoe shine set consisting of two brushes, a metal shoehorn with clothes brush, two shoe creams (black and colorless), a cloth and a cream applicator sponge. We laser your logo on the metal emblem.

➤ 15 × 15 × 4,7 cm

☒ L3

☒ 4 × 1



3162

sewing kit Melbourne

Travel sewing kit in an eco-friendly packaging with all the necessary utensils for a quick repair. Your logo will be printed on the paper bag.

- ↗ 4,4 × 0,8 × 6,6 cm
- ⊗ T2
- ☒ 3 × 3



8003

Travel sewing set Le Havre

This travel sewing kit in practical credit card format always finds a place when traveling. We apply your advertising imprint on the card case.

- ↗ 8,8 × 5,4 × 0,7 cm
- ⊗ T2
- ☒ 6 × 4



8824

1.5 meter tailor measuring tape Buenos Aires

A round thing! Practical plastic measuring tape with measuring range up to 1.5 m. Ideal for measuring bodies, as this measuring tape is fully flexible - except for the length. We will print your logo on the enclosure.

- ↗ ø 5 × 1,5 cm
- ⊗ T2
- ☒ ø 3,5

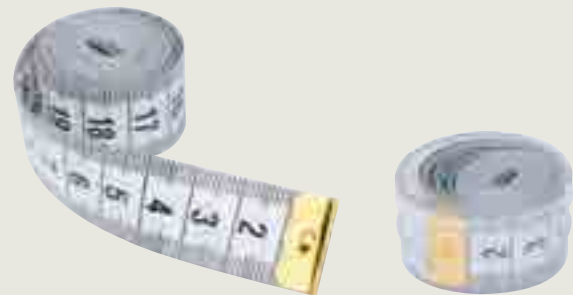

2298

Measuring tape Binche

Tailor's tape measure made of polyfiber fabric with a running distance of 1.5 m in a plastic box. The lid of the package is perfect for an advertising imprint.

- ↗ ø 4,3 × 2,3 cm
- ⊗ T2
- ☒ ø 3



2189

Cosmetic Bag Arlon

Cosmetic cotton bag with cork bottom and zipper closure. Your Logo will be printed on one side of the bag.

- ✂ 21,5 × 5 × 16 cm
- 📏 S1
- 📦 12 × 8



2446

Personal scales Herve

Digital bamboo personal scale with a maximum loading weight of 150 kg. The notifications can be shown in kg/lb/st. Your logo will be engraved on the scale.

- ✂ 28 × 28 × 2,9 cm
- 📏 L3
- 📦 5 × 3



ECO

BAMBOO



3255

Make-up mirror Teplice

Handy pocket mirror made of bamboo. This mirror should not be missing in any hand luggage or handbag. Your logo will be engraved on the back. Due to the natural bamboo grain, each item and each engraving is unique.

✂ $\varnothing 7 \times 1$ cm
 ☒ L2
 ☒ $\varnothing 5$



METAL, PU

0424

Pocket double mirror Scandicci

Unbreakable double mirror - how? Made from polished metal. The view is bright - regular on one side, magnified on the other. The white cover outside makes it perfect looking. Your logo will be laser engraved.

✂ $5,8 \times 6 \times 1$ cm
 ☒ L3
 ☒ 4×4

ECO

BAMBOO

RECYCLED PAPER

60 TISSUES WOODFREE



0492

Tissuebox with 60 three-ply tissues

Handkerchief box with 60 handkerchiefs made of bamboo, 3-ply, 100% woodfree, and recycled box. Your logo will be printed on the box.

✂ $11,5 \times 11,5 \times 11,5$ cm
 ☒ S1
 ☒ 3×3



3751

RPET Manicure Set Kraków

Attractive manicure set made of felt (recycled PET). It includes nail scissors, a nail file, nail clippers, tweezers and two cuticle pusher. We place your logo on the front of the case.

- ✓ 10,7 × 6 × 2 cm
- ✂ TT1
- ☑ 5 × 5



2793

Manicure set Avola

Manicure set in PVC case with metal frame including nail scissors, nail file, nail clippers and tweezers. We print your logo on the case.

- ✓ 10,8 × 6,8 × 2,3 cm
- ✂ S1
- ☑ 5 × 3



3233

Dog waste dispenser Leipzig

Screw-on dog waste bag dispenser in the shape of a bone with plastic carabiner and 15 biodegradable bags. Your logo will be printed onto the case.

- ✓ 8 × 3,7 × 5,2 cm
- ✂ T2
- ☑ 2 × 1

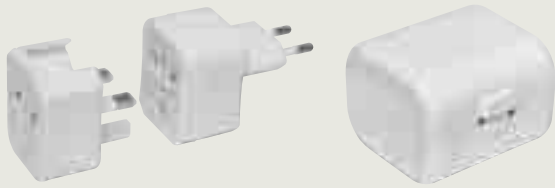

ABS,



0394

Travel adapter

Wherever you travel to - from now on - you have always the needed adapter with you (US,UK,AUS,EU). Your logo will be printed onto the box.

- ✂ 6,2 × 5,9 × 4,6 cm
- ☒ T3
- ☒ 4 × 2,5



PLASTIC



WORLDWIDE
ADAPTER SET

2097

Travel Adapter Antwerp

Travel Adapter for Europe, USA, UK and Australia. Featuring 2 USB outputs with 2.100 mA. Your Logo will be printed on one side of the adapter.

- ✂ 9 × 3,5 × 10,5 cm
- ☒ T4
- ☒ 4 × 2,5



 POLYESTER
POLARFLEECE  BLANKET SIZE:
180 X 120 CM



2775

2in1 fleece blanket/pillow Radcliff

Fleece blanket (grammage 170 g/m², size: 180 x 120cm) with zipper, which by folding then turns into a pillow. We embroider your logo on the blanket.

-  31 x 7,5 x 30 cm
-  HF
-  6 x 4



 POLYESTER
FLEECE  BLANKET SIZE:
180 X 120 CM



6902

Big fleece blanket Nashville

Snugly! This fluffy fleece blanket with carrying strap is ideal for getting cozy at home, or keep it in the car, as it is ideal for a picnic, camping, etc. Please check size when buying the blanket. We will print your logo onto the black surface between the straps.

-  180 x 120 cm
-  TT2
-  10 x 4



 POLYESTER FLEECE  BLANKET SIZE:
150 X 120 CM  WATERRESISTANT



3319

Universal blanket Arnhem

Perfect blanket! This fleece blanket (120 x 150 cm) made of polyester fleece (150 gsm) is not only a perfect picnic blanket, due to its foil at the bottom it protects from wet and dirt. It can easily be transported with the lap with Velcro closure. We will print your logo centred on the lap. Single-packed in a poly bag.

-  30,5 x 21 x 10,5 cm
-  TT2
-  15 x 8



POLYESTER-
FLANNEL-
FLEECE

BLANKET SIZE:
180 x 200 CM



3750

blanket Kaunas

Blanket made of polyester flannel fleece (grammage 230 gsm) with a size of 180 x 120 cm. Perfect for the cold days. We print your logo on the banderole.

✂ 150 x 200 cm

📦 S1

📦 8 x 6



03

05

44

STAINLESS STEEL,
CARDBOARD,
FLEECE

500 ML

LEAKPROOF,
VACUUM,
BLANKET SIZE: 180
x 120 CM

FOOD SAFE

3478

Set fleece blanket + thermal flask Liverpool

Perfect duo! Your customers will have all they need for a cuddly evening or a journey with this nice set. You will receive a nice 2-in-1 fleece blanket, which can be converted to a pillow by means of the attached zipper and a thermal flask with 500 ml content. We will either engrave your logo on the flask or by means of embroidery on the blanket. Single-packed in box.

✂ 30 x 40 x 8 cm

📦 L3

📦 4 x 4



PLASTIC

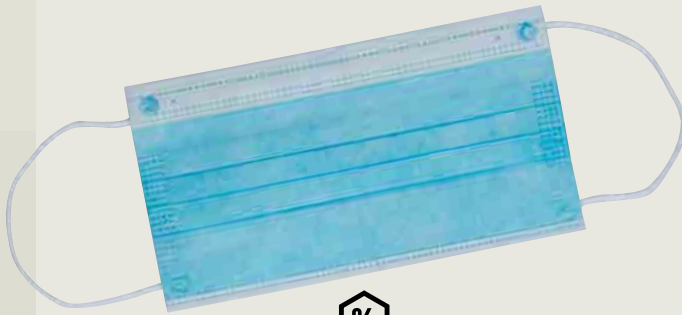

TOP PRICE

2031

Face Mask Taranto

TOP PRICE! Disposable Face Mask (Mouth-Nose Protector) 3-ply with rubber band holder and wire bracket for fixation. We print your logo on the outside of the mask.

- ✂ 17,5 × 9,6 cm
- ✂ TT1
- 📦 5 × 1,5



METAL, ALUMINIUM, PLASTIC

1 000 ML

TOP PRICE

1726

Desinfective column Saint John

TOP PRICE! Disinfection column with stable base, a telescopic pole (125-165 cm), a DIN A4 sized advertising space and a container with 1000 ml capacity for disinfection gel or liquid, batteries are not included. Ideal for government offices, restaurants, stores or companies. You can print your logo yourself on DIN A4 and customize it at any time.

- ✂ 120 × 80 cm

COTTON



TOP PRICE



03



06



0464

Face mask Surprise

Oeko-Text® STANDARD 100 certified cotton face mask (mouth and nose protection) 2-ply (outside 225g / m², inside 145 g / m²) with elastic strap. We will print your logo on the outside of the mask.

- ✂ 22 × 12 cm
- ✂ ST
- 📦 6 × 3

NON WOVEN

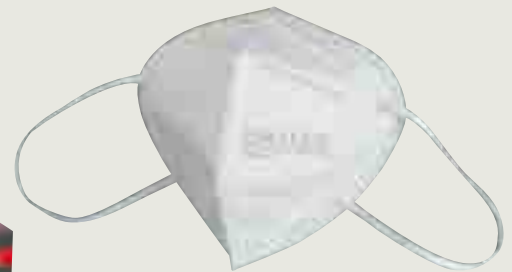

TOP PRICE

2520

FFP2 mask La Rioja

FFP2 mask according to EN149:2001 + A1:2009 standard. The 5-layer mask has an integrated nose clip for adjusting to the face shape and two ear loops. The mask body is made of non-woven fleece layers, "meltblown" filter fleece and cotton. We print your logo on one side of the mask.

- ✂ 16 × 12 cm
- ✂ TT1
- 📦 4 × 3



PLASTIC

100 ML

TOP PRICE



1657

Desinfection gel Rio Grande

TOP PRICE! Practical desinfection gel 100ml for outdoor or at home. The gel with 65% ethanol works against bacteria and certain viruses. We print your advertising on a label and put it on the bottle

- ✂ ø 4,5 × 11,5 cm
- ✂ ETN2
- ✂ 14 × 6,5



PLASTIC

30 ML

TOP PRICE



7916

Disinfectant gel Sunderland

Disinfectant gel with a filling capacity of 30 ml in a plastic vial with carabiner, perfect for traveling. Your logo will be printed on the vial.

- ✂ 9,9 × 3,6 × 2,5 cm
- ✂ T2
- ✂ 4 × 2



PLASTIC

250 ML

TOP PRICE

3939

Desinfection spray Rochester

TOP PRICE! Disinfectant spray 250 ml for almost all surfaces. Has an antibacterial effect and against special viruses. Your logo will be attached to the bottle using a label.

- ✂ ø 4,9 × 19 cm
- ✂ ETN2
- ✂ 6 × 12



PLASTIC

300 ML

TOP PRICE



8887

Desinfection gel Rio Verde

Dispenser with 300 ml disinfectant gel, is effective against 99.9% of all bacteria and certain viruses. We will print your advertising on a label and attach it to the dispenser.

- ✂ ø 6,9 × 14 cm
- ✂ ETN1
- ✂ 10 × 5,5



03



05



06



07



44

3223

RPET umbrella Ipswich

Automatic pocket umbrella with fibreglass frame, cover made of recycled PET bottles, wooden handle and wrist strap. Your logo will be printed on one segment.

✂ ø 100 x 56,7 cm

☒ S2

☒ 15 x 10





03

05

99

44



190T PONGEE



STORM PROOF
UP TO 180 KM/H,
AUTOMATIC
OPEN + CLOSE



3819

Pocket Umbrella Omaha

Extremely robust luxury pocket umbrella with automatic opening and closing, rubberised handle, fibreglass and metal poles, 190T pongee covering and a matching colour protective cover. Storm-proof up to 180 kmh wind speed. We print your logo on a segment.

✂ ⌀ 103 × 65 cm

☒ S2

☒ 15 × 10



03

05

44



190T PONGEE



AUTOMATIC
OPEN + CLOSE,
STORM PROOF



3519

Umbrella with storm function Bixby

The perfect attender for english weather. This pocket umbrella with storm function, made of 190T pongee and a fibreglass/metal handle keeps you always protected of rain and wind. We have also a automatic open and closing function.

✂ ⌀ 96 × 31 cm

☒ S2

☒ 20 × 15

190T PONGEE

SNAP HOOK



TOP PRICE

0885

Umbrella Erding

TOP PRICE! Elegant pocket umbrella with rubberized carabiner handle. We print your logo on a segment.

- ☞ ø 98 × 68 cm
- ☒ S2
- ☒ 15 × 10

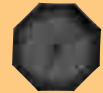

03

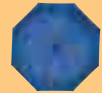

04



05



06



44



170T POLYESTER

WRIST STRAP



TOP PRICE

5188

Collapsible umbrella Lille

TOP PRICE! Small and handy, so you can take it everywhere. A handy collapsible umbrella with a metal telescopic bar and 170T Polyester canopy, a black plastic grip and a hand loop. We will place your logo on one panel of the umbrella.

- ☞ ø 85 × 33 cm
- ☒ S2
- ☒ 15 × 10



02

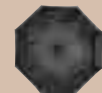

03

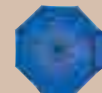

04



05



06

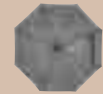

07



08

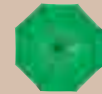

09



10



11



12

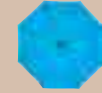

24



29

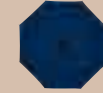

44

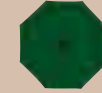

99



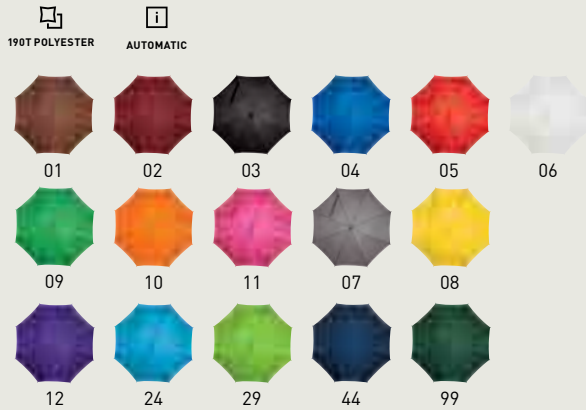



5131

Wooden automatic umbrella Nancy

The classic, automatic umbrella with 190T polyester cover, real wood shaft & handle and a metal frame with high performance automatic spring. We print your logo on a segment.

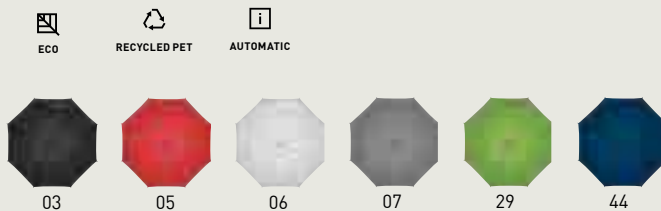

-  ø 105 x 88 cm
-  S2
-  20 x 15



2436

Automatic Umbrella Hasselt

High-quality automatic and windproof umbrella with fiber glass shaft and curved wooden handle. Your logo will be printed on one panel.

-  ø 105 x 88 cm
-  S2
-  20 x 15





TOP PRICE

170T POLYESTER AUTOMATIC



5086

Automatic walking-stick umbrella Le Mans

TOP PRICE! Automatic umbrella with metal frame, straight wooden handle and 170T polyester covering. Your logo will be printed on one segment.

- ✂ ø 100 × 83 cm
- ☒ S2
- ☒ 20 × 15



TOP PRICE

170T POLYESTER AUTOMATIC



5085

Automatic walking-stick umbrella Aix-en-Provence

TOP PRICE! Automatic umbrella with metal frame, straight wooden handle and 170T polyester covering. Your logo will be printed on one segment.

- ✂ ø 100 × 83 cm
- ☒ S2
- ☒ 20 × 15



TOP PRICE

170T POLYESTER AUTOMATIC



5200

Automatic umbrella Limoges

TOP PRICE! The umbrella with 170T polyester cover, curved handle, metal pole and automatic opening provides the ideal platform. We print your logo on one segment.

- ✂ ø 108 × 83 cm
- ☒ S2
- ☒ 20 × 15

190T POLYESTER

AUTOMATIC



03



04



05



06



11



44



3596

Automatic umbrella Stockport

Automatic umbrella made of 190T polyester with curved wooden handle and wooden tips. Your logo will be printed on the lower part of one segment.

☞ ø 105 × 89 cm

☒ S2

☒ 20 × 15

190T POLYESTER

AUTOMATIC



5137

Umbrella Sarajevo

Attractive, multicolor automatic umbrella with curved wooden handle. We print your logo on a segment.

☞ ø 105 × 83 cm

☒ S2

☒ 20 × 15

190T POLYESTER

AUTOMATIC



08

11

14

29

3472

Automatic umbrella Paris

Automatic umbrella made of 190T pongee with fiberglass poles, plastic handle, colored rim, handle and frame. We print your logo on one segment.

☞ ø 103 × 85,5 cm

☒ S2

☒ 20 × 15



 190T POLYESTER

 SOFT GRIP



 XXL



1529

Umbrella Get seen

Large umbrella which will draw attention to itself and your logo thanks to its black-neon and yellow color contrast (190T polyester.) We print your logo on a segment.

 ø 123 x 97 cm
 S1
 20 x 20



 170T POLYESTER

 AUTOMATIC,
SOFT GRIP



04



05



07



08





09

2416

Automatic umbrella Ghent

Automatic 170T polyester umbrella with aluminium shaft, a soft-touch handle and panel in different colours. Your logo will be printed on one panel.

 89 x 89 x 83 cm
 S2
 20 x 15



 190T POLYESTER

 AUTOMATIC,
SOFT GRIP

 XXL



04



05



08



09





10

1531

Large umbrella Suederdeich

Large umbrella with automatic function and 190T polyester cover. We print your logo on a segment.

 ø 130 x 99 cm
 S2
 15 x 10



190T POLYESTER

AUTOMATIC,
SOFT GRIP



03



44



99

5202

Automatic umbrella with UV protection Avignon

Automatic umbrella with soft foam handle. It is extremely lightweight and made of 190T polyester, which is matt silver coated inside. We print your logo on one segment.

☞ ø 100 x 85 cm

☒ S2

☒ 20 x 15



190T POLYESTER

STORM SAFE,
SOFT GRIP

XXL



5187

XL storm umbrella Hurrigan

Storm umbrella with buckling technology, carbon shaft, a flexible pole made of fiberglass and a 190T polyester covering. We print your logo on a segment.

☞ ø 123 x 100,5 cm

☒ S2

☒ 25 x 20

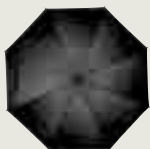

03

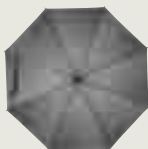

07

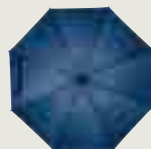

44

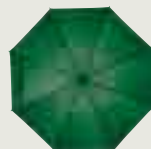

99



PVC



PHTHALATE FREE



48

37

49

9205

Turn-over rain coat Nanterre

Reversible PVC rain jacket with hood, two pockets and press studs. We put your logo on one side of the chest.

- ✂ 103 × 60 cm
- 📏 S1
- 📦 15 × 10



PLASTIC



PHTHALATE FREE

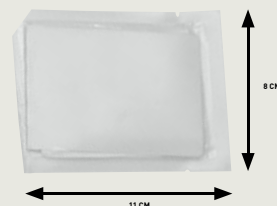

8 CM

11 CM



0978

Rain poncho Great Falls

Rain poncho folded in a credit card size packaging, perfect for every wallet! We print your logo on the packaging (1C, for multicolour on request).

- ✂ 11 × 8 cm
- 📏 T2
- 📦 4 × 4



PLASTIC



PHTHALATE FREE



05

08

09

2323

Rain poncho Regensburg

Phthalate-Free, transparent rain poncho inside a small can with carabiner to attach. Perfect for being on the move. Your logo will be printed onto the can.

- ✂ 5 × ø 5,5 cm
- 📏 T3
- 📦 ø 3



POLYESTER



REFLECTIVE



2671

Rain poncho Monte Carlo

Foldable rain poncho with reflective stripes and a drawstring for the hood, which can be folded into a belt pouch. Perfect for stowing away, this poncho should always be with you. Your logo will be printed on the bag.

- ✂ 18 × 16 × 10 cm
- 📏 S2
- 📦 11 × 3



1882

Compostable rain poncho Fleurus

Phthalate-free compostable rain poncho made from PLA with carrier bag. This poncho is a sustainable alternative. Your logo will be printed on the bag.

- ✂ 14 × 12 cm
- ✂ ETN1
- 📏 5 × 5



9101

Rain coat Clermont-Ferrand

PVC rain jacket (one size XL) transparent frosted with hood, two front pockets and snap buttons. We will print your logo on the chest (heart side).

- ✂ 17,5 × 23 cm
- ✂ TT3
- 📏 10 × 6



9218

Emergency poncho Tours

Fast protection from rain! Practical transparent rain emergency poncho in one size. You should always have it with you in case of emergencies! A top item for all outdoor events - and for anyone who wants to protect him/herself from the rain. We will place your logo on a label (up to 4 colours) on the cover of the poncho.

- ✂ 16 × 9 cm
- ✂ ETN2
- 📏 9 × 13

 POLYESTER,
STEEL

 FOLDABLE

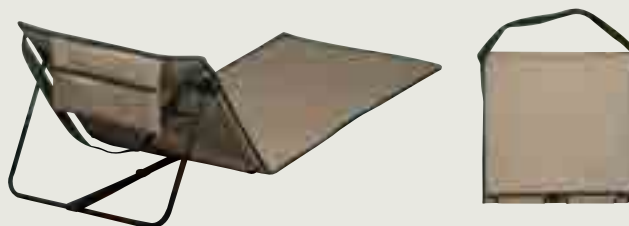

2668

Beach mat Valladolid

Foldable beach mat made of robust 600D polyester with a foldable steel backrest. So you always lie comfortably. Your logo will be printed on the mat.

 160 × 53 × 2,5 cm

 TT3

 20 × 10

 POLYESTER,
METAL



5104

Foldable chair Yosemite

Foldable armchair with sturdy steel frame, high quality sturdy polyester cover, integrated drink holder, carrying bag and load capacity up to 100 KG. We print your logo on the carrying bag.

 85 × 80 × 50 cm

 TT3

 15 × 8

 POLYESTER,
METAL



5070

Beach umbrella Fort Lauderdale

Sunshine is great - but you need to protect yourself from it. Shade yourself with our high quality beach umbrella. The white-lacquered metal bar is separate and highly adjustable, the material is made of polyester and the inner spokes are made of white-lacquered metal matching the border. The sun umbrella is packed in a transparent carrying bag. We will put your logo on one of the panels.

 ø 135 × 170 cm

 S2

 20 × 20

04

05

06

08

10



PVC



PHTHALATE
FREE



10



09



08



06



05



04

1041

Air mattress Long Beach

Multi-purpose mattress, for floating on water, as a spare bed for your house or the perfect camping companion. This air mattress has a 2-vault system. We print your logo on the cushion of the mattress.

✂ 173 × 66 × 15 cm

☒ S2

☒ 16 × 8



1029

Frosty beach ball Orlando

Beach ball with an appealing look by its transparent frosted colours. Our beach balls are 100% PHTHALATE-FREE. Your logo will be printed on the panel.

- ø 26 cm
- TT1
- 16 x 4



04



05



06



08



09



10



11



12

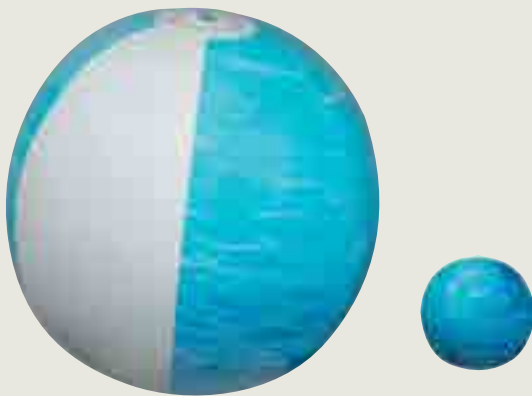

8664

Beach ball Malibu

Phthalate-free PVC beach ball in sea look with a segment length of 40 cm. Your logo will be printed on the free white segment.

- ø 26 cm
- S1
- 16 x 4



8260

Multicolour beach ball Palm Springs

Multicolor beach ball with six different colored segments. Segment length approx. 40 cm. We print your logo on the white segment.

- ø 26 cm
- TT1
- 16 x 4



1051

Bicolour beach ball Key West

A bicolour beach ball is a must-have as a gift. Our beach balls are 100% PHTHALATE-FREE. Your logo will be printed on the white segment.

- ↗ ø 26 cm
- ⊞ TT1
- ⊞ 16 × 4

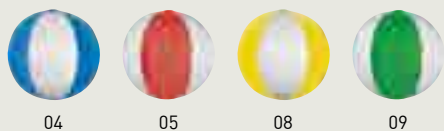

0914

Beach ball Montepulciano

Trendy beach ball with colored transparent and white segments. We print your logo on a segment.

- ↗ ø 26 cm
- ⊞ TT1
- ⊞ 16 × 4

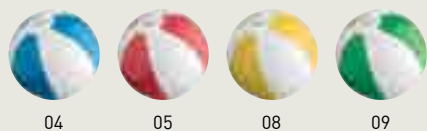

8261

Mini beach ball Acapulco

Mini beach ball for fun beach games. We print your logo on a white segment.

- ↗ ø 14 cm
- ⊞ S1
- ⊞ 8 × 2



8639

Swim ring Beveren

More fun on the beach! With the inflatable PVC swim ring it's much more fun to relax in the sea or in a swimming pool. We will pad print your logo onto one side of the ring.

- ✂ \varnothing 48 x 10 cm
- ☒ TT1
- ☒ 15 x 7



05



10



04



0844

Mobile phone case Sunbury

Waterproof phone case with loop and panic lock. We print your logo centered on the bag.

- ✂ 22 x 10,9 x 0,8 cm
- ☒ T3
- ☒ 5 x 2



2835

Tablet cover Malta

Protective! With this practical plastic case, your customers' tablets are protected from water and sand while it can still be used. We print your logo on the black edge of the case.

- ✂ 22 x 0,2 x 35 cm
- ☒ T3
- ☒ 5 x 3



0390

Beach bucket

Beach bucket with sand accessories for kids. Your logo will be placed onto the net with a label.

- ✂ \varnothing 13 x 15 cm
- ☒ ETN1
- ☒ 4 x 5



PLASTIC



ECO

WOOD



3817

Bird House Pretoria

Bird house made of wood assemble. Your logowill be laser engraved on the front.

- ✂ 11,5 x 11,5 x 17,5 cm
- ☒ L3
- ☒ 5 x 5



 PVC, PLASTIC,
STAINLESS STEEL

 FOR 2 PERSONS,
ISOLATING,
VACUUM,
LEAKPROOF

 1000 ML + 2x200ML

 KEEP 24H WARM/
36H COLD

 FOOD SAFE



6605

Luxurious picnic backpack with cool bag Georgia

Luxurious picnic backpack. The high-quality robust outer material made of polyester and its compactness make it a really amazing item. But it provides even more: a cooling compartment on the back and a spacious inner compartment including excellent equipment like, a stainless steel isolating flask with 1L capacity, two 0,2l stainless steel cups, stainless steel salt and pepper shakers, a snack tray, cutlery and napkins. We will put your logo on the front compartment.

 25 x 16,5 x 34,5 cm

 TT3

 12 x 6



 600D POLYESTER,
STAINLESS STEEL,
PLASTIC

 FOR 4 PERSONS,
ISOLATING

 FOOD SAFE



2975

Picnic bag Mumbai

Picnic bag for 4 people with handle and shoulder strap. There is also a cooling compartment in the picnic bag, which cools your food and drinks even on warm days. Plates and cutlery for 4 people. We'll print your logo on the bag.

 36 x 33 x 28 cm

 TT3

 15 x 8

 POLYESTER,
PLASTIC

 FOR 4 PERSONS,
ISOLATING

 FOOD SAFE



6607

High-class picnic backpack Virginia

Relax in nature! Enjoy a cozy picnic for 4 with this high-quality polyester picnic backpack. It contains a spacious cooling compartment at the back for keeping your food fresh, two bottle cooling compartments at the sides, plenty of equipment in the front compartment like plastic dishes and glasses, cutlery, a small plastic tray, a corkscrew, a salt and pepper shaker and a knife. The front compartment provides further storage space. We will put your logo on the front compartment.

 47 x 19 x 44 cm

 TT3

 10 x 5



 WILLOW, CERAMIC,
 STAINLESS STEEL,
 PLASTIC

 FOR 2 PERSONS

 FOOD SAFE



1446

Picnic basket Emmerlev

Mini wicker picnic basket for two. With ceramic plates and cups, stainless steel cutlery, salt and pepper shaker. Your logo will be engraved or digitally printed on an aluminium label attached to the basket.

📏 37 × 25,5 × 16,7 cm

🏷️ ETP

📦 4,5 × 3



 WILLOW, CERAMIC,
 STAINLESS STEEL,
 PLASTIC

 FOR 2 PERSONS,
 ISOLATING

 FOOD SAFE

0858

Picnic basket Riva del Garda

Large picnic basket for two - in wicker, with integrated cooler bag, ceramic plates and plastic jars, stainless steel cutlery, waiter's knife, and salt and pepper shakers. We print your logo (full color) on a tag, which is hung to the basket.

📏 37,5 × 19 × 26 cm

🏷️ ETP

📦 4,5 × 3





PVC



TOURNAMENT SIZE



1494

Football - Champion

Classic football in tournament size. Your logo will be printed on a free white segment.

- ✂ \varnothing 21 cm
- ✂ TT2
- ✂ 3,5 x 3,5



RESIN,
NATURAL RUBBER



SET OF 3 BALLS



1279

Golf balls

For golfers who want to play their best score! The golf balls have a soft feel, high ball flight and outstanding length. The golf balls are rounded off with a print and the environmentally friendly packaging. Indicated printing price per set (3 balls).

- ✂ 13,5 x 4,5 x 4,5 cm
- ✂ DC3
- ✂ \varnothing 2



STAINLESS STEEL,
PLASTIC, POLYESTER,
WOOD



3602

Boules game Jacksonville

How about a little game? Kill some time on the beach with this elegant big boules game with 6 metal balls, 1 small wooden ball and a measuring tape. Presented in a practical nylon carrying bag. The balls can be distinguished by the different rings - this boules game is suitable for up to 3 people. We will put your logo on the boules bag.

- ✂ 23 x 7 x 16 cm
- ✂ TT2
- ✂ 15 x 8



PLASTIC,
NATURAL RUBBER

SET OF 3

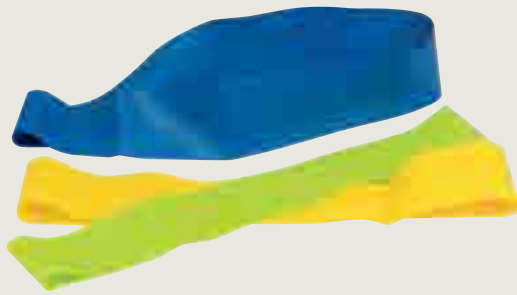

2424

Elastic fitness straps Rosario

Mini gym to go! With these elastic fitness straps you can do your workout anytime and anywhere! Comes in a plastic box on which we will print your logo.

- ✂ 13 × 6,9 × 2,4 cm
- ☒ T3
- ☒ 5 × 3

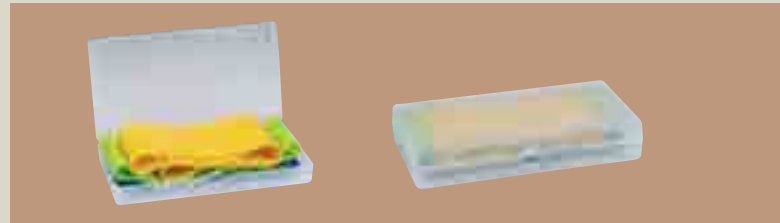

PLASTIC

SOFT GRIPN

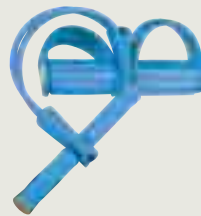

2471

Abdominal and back trainer Rochefort

This soft grip abdominal and back trainer with foot loop shapes, strengthens and tones your muscles and is also applicable for arms and legs. Your logo will be printed on one handle.

- ✂ 25,5 × 4,7 × 52 cm
- ☒ L3
- ☒ 4 × 1,5



PLASTIC,
NATURAL RUBBER

SOFT GRIPN

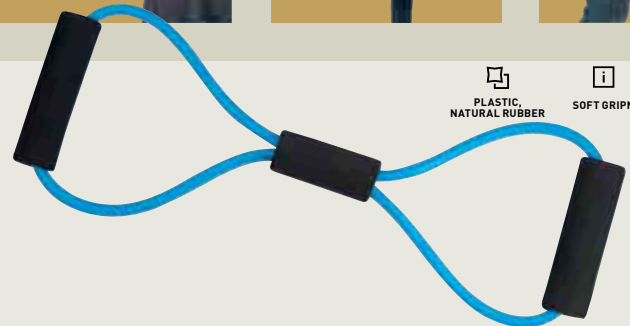

2467

Fitness expander Resistencia

Soft-grip expander, versatile in use, gentle to joints, perfectly suitable for your home workout. Your logo will be placed on the middle part.

- ✂ 39 × 3 × 13,5 cm
- ☒ L3
- ☒ 5 × 1



11



24

EVA

SIZE 175 x 60 CM



2511

Yoga-Matte San Bernardo

EVA yoga mat with elastic band to close. Suitable for indoor and outdoor use, can also be used as a sports, pilates, gymnastics or fitness mat. Your logo will be printed on the mat.

✂ 175 x 60 x 0,5 cm

☒ L3

☒ 6 x 3

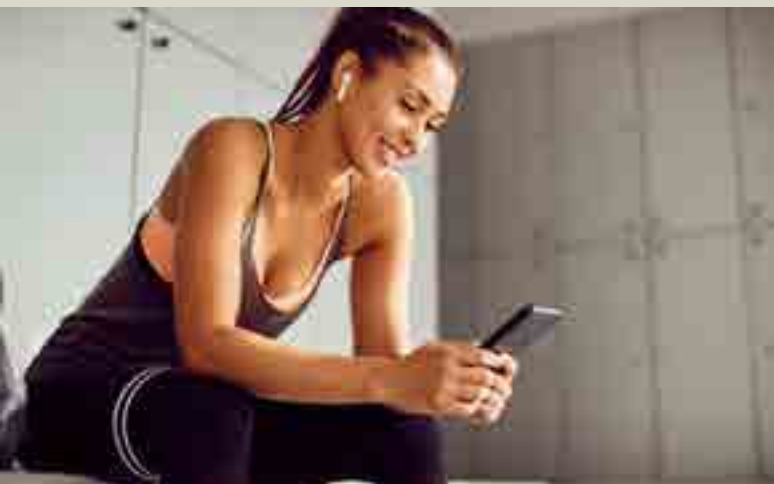

04



05



06

PLASTIC,
POLYESTER

COOLING
FUNCTION

WIPE SIZE
80 x 30 CM



0884

Sports towel Sporty

Great companion for sports, cooling towel packed in a plastic bottle with carabiner. We print your logo on the bottle (only 1C feasible).

✂ ø 6,3 x 16,5 cm

☒ T4

☒ 3 x 3



PLASTIC



3938

Puzzle game Albany

Take it easy! Try to keep your patience with various puzzle games. 24 various games per carton. The prices are per game. We will print your logo directly onto the plastic dice.

- ✂ 4 × 4 × 4 cm
- ☒ T2
- ☒ 3 × 3



PLASTIC



CMYK ALLOVER
PRINT



0178

Sliding puzzle Haro

Plastic sliding puzzle game with 15 pieces and a stopper. We will print your logo alllover with digital print.

- ✂ 7,4 × 0,5 × 8,8 cm
- ☒ DC1
- ☒ 5,5 × 7,3



PLASTIC

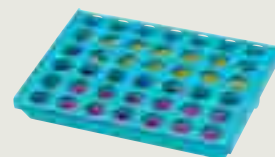

2292

4 in a row game Genk

4 in a row - game made of plastic with yellow and pink stones, the playing field can be folded and thus this game is ideal for longer bus, train or car trips. Your logo will be placed on the playing field.

- ✂ 20,7 × 14,9 × 2,9 cm
- ☒ T3
- ☒ 6 × 0,4



04

05

06

08

09

10



8622

Anti-stress ball Karabuk

Anti-stress crushable ball made of kneadable foam. Relieve stress or train your finger muscles. We will laser engrave your logo onto the ball.

✓ ø 6,3 cm

✘ L2

☒ 3 × 1,5



2718

Anti-stress football

Anti-stress squeeze football made of foam; train your hand muscles or simply relieve some stress. Your logo will be printed on the free white area.

✓ ø 5,6 cm

✘ L2

☒ ø 1,5



2308

Squeeze duck Blankenberge

Squeeze Duck made from PVC. Pure Bath joy for everyone. Your Logo will be printed on the Duck.

✓ 7,6 × 6,9 × 7 cm

✘ T3

☒ 2,5 × 1



2676

Wooden puzzle Toulouse

Make your customers happy with this beautiful 3D star-shaped wooden puzzle. The closable cotton bag ensures that nothing gets lost. We will print your logo on the bag. Print only 1 colour.

- ✂ 5 cm
- ♻ S1
- 📦 5 × 5



2912

Wooden puzzle Porto

Sustainable classic game made of wood. Promote creativity with this wooden puzzle and give a nice pastime. So you will surely be fondly remembered. We will attach your logo to the single packaging by means of a sticker.

- ✂ 10,2 × 10,3 × 0,5 cm
- ♻ ETN1
- 📦 4 × 2



ECO



WOOD, COTTON



3234

Wooden counting game Liberec

32-piece wooden counting game, delivered in an eco-friendly cotton bag. Your logo will be printed onto the bag.

📏 10 × 2,5 × 12 cm

📦 S1

📦 3 × 3



ECO



PINE (WOOD)

2911

Puzzle Rennes

Puzzle wooden maze with a metal ball. Patiently work your way through all the obstacles from start to finish. We will print your logo on the puzzle.

📏 9 × 9 × 2,5 cm

📦 S1

📦 6 × 2

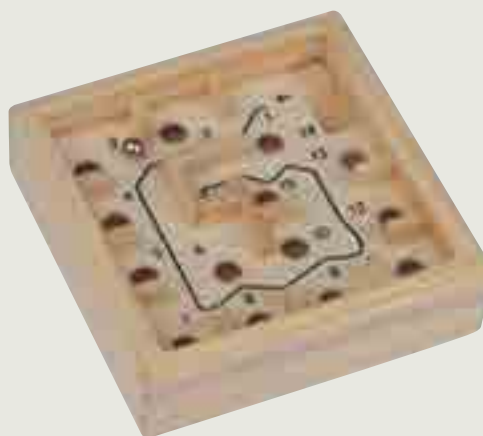



ECO



WOOD



2346

Mikado and Domino Game Foligno

Wooden mikado and domino game with different colors packed in a sustainable wood box. Your Logo will be printed on the box.

✂ 19,6 × 9,1 × 2,9 cm

📦 T3

📏 5 × 2



ECO



WOOD



0979

Game of dominoes Ko Samui

Domino game made of wood. We print your logo on the front lid.

✂ 14,5 × 4,9 × 2,8 cm

📦 T2

📏 5 × 2

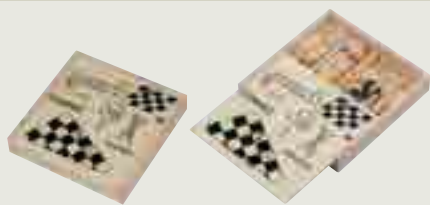

ECO



WOOD



2697

Wooden game collection Riga

For lasting fun! Game collection in a wooden box consisting of chess, mikado, checkers and dominoes. The next game night completely in a box including you with your logo. We will print these on to the box.

✂ 16,5 × 16,5 × 3 cm

☒ S1

☒ 8 × 2



2626

Playing cards Newcastle

For sustainable gaming fun. Classic card game with a French leaf (Skat) made from recycled paper in a recycled cardboard box. Your logo will be placed on the box.

- 📏 6 × 1,7 × 9 cm
- 📦 T2
- 📏 4 × 1,5



0980

Mikado game Fort Meyers

Mikado game, the classic for every occasion. Your logo is printed on the front.

- 📏 19 × 4,2 × 2,1 cm
- 📦 T2
- 📏 5 × 2



3745

Scratching block Innsbruck

Scratch pad (10 sheets) made of cardboard including wooden pencil. Not only children can give free rein to their creativity. The rainbow layer under the black coating makes it easy to create colourful works of art with the wooden pen. We print your logo on the cover of the pad.

✂ 10,6 × 14,5 × 0,5 cm

📏 T3

📦 5 × 3



CARBON, CHALK

3679

Chalk eggs Stavanger

Chalk eggs in yellow, orange, red, green, blue and purple in an egg cardboard box. Your logo will be printed on the cardboard.

✂ 15 × 10 × 7 cm

📏 T3

📦 5 × 5





PVC



REFLECTIVE



2890

sticker Stanley

A smile for more safety! Your small customers will be perfectly seen and safe with this reflecting PVC sticker, which they can attach to the satchel, jacket, bike, etc. Due to its funny face it will be likely used by everyone. We will print your logo onto the sticker. Single-packed in poly bag.

- ✂ \varnothing 7 cm
- ✂ T2
- 📦 1,5 x 1,5



PVC



REFLECTIVE



2889

pendant Oakley

A smile for more safety! Your small customers will be perfectly seen and safe with this reflecting PVC pendant, which they can attach to the satchel, jacket, bike, etc. Due to its funny face it will be likely used by everyone. We will print your logo centered on the front, under the eyes. Single-packed in poly bag.

- ✂ \varnothing 4,9 cm
- ✂ T2
- 📦 \varnothing 3



PLASTIC



REFLECTIVE



2449

Keyring Bear

Reflecting Keyring in the shape of a bear. Your logo will be printed onto the bear.

- ✂ 5 x 0,7 x 7 cm
- ✂ T2
- 📦 4 x 1,3



PVC



REFLECTIVE



0947

Keyring Speedy

Keyring in the shape of a safety vest with reflective stripes. We print your logo above the stripes.

- ✂ 4,3 x 0,5 x 5,9 cm
- ✂ T2
- 📦 2 x 2



PVC, METAL



REFLECTIVE

06 08 10 11

8157

Snap bracelet Teneriffa

Flexible, reflective snap bracelet made of plastic with metal spring. We place your advertising imprint on the reflector surface. Due to the material, the print is only possible in one color in black.

- ✂ 32 × 3,2 cm
- ✂ T3
- ✂ 4,5 × 1,5

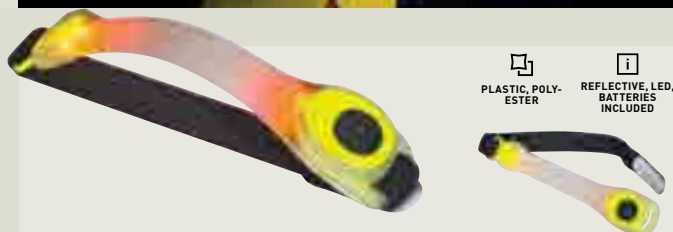

PLASTIC, POLY-ESTER



REFLECTIVE, LED, BATTERIES INCLUDED

3412

Safety LED wrist band Pittsburgh

Safety LED wristband with two red LEDs with two light modes: steady light and flashing and a reflector strip on the closure. We print your logo on the transparent plastic part in the middle. Two button cells are already included.

- ✂ 18,5 × 4,2 × 1,9 cm
- ✂ T4
- ✂ 5 × 1,2



POLYESTER



REFLECTIVE



1431

Safety bracelet Vester

Flexible, reflective safety snap bracelet made of plastic with metal spring. Your logo will be printed on the reflective surface.

- ✂ 35,8 × 3,1 × 0,5 cm
- ✂ L2
- ✂ 9 × 1,5



POLYESTER



REFLECTIVE

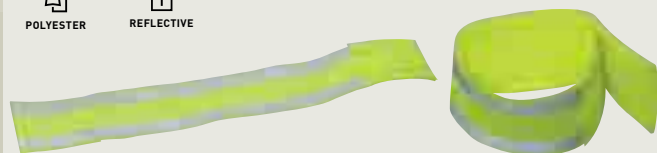

0468

Reflective arm band

Get better seen - during daylight and in the night - neon yellow and 2 reflective stripes - will take care. We will print your logo on the tape, preferably in a dark printing color (light colors are difficult to see on the material).

- ✂ 32,4 × 5,1 cm
- ✂ S1
- ✂ 14 × 1,5



POLYESTER

CLASS 2, ISO 20471,
REFLECTIVE

0995

Safety jacket Venlo

High visibility vest made of polyester. Meets all EU standards. We print your logo on the chest (heart side). Printing on the back possible on request.

✂ 68,5 × 62,5 cm

📏 S2

📏 10 × 8



POLYESTER



EN 1150:1999,
REFLECTIVE



2888

Children's safety jacket Ilo

For more safety! Even the smallest won't be overseen with this safety jacket. This safety jacket is the right companion in traffic or on the way to school. Needless to say that it complies with all EU standards. We will print your logo on the chest (heart side). Print on the back upon request. Single-packed in poly bag.

- ✂ 50 x 44 cm
- 📦 S2
- 📦 10 x 6



500D PVC



WATERPROOF,
BACKPACK-FUNC-
TION, REFLECTIVE



1516

Waterproof bag Malmedy

Neon-colored, waterproof closable bag with 2 adjustable shoulder straps. So the bag can be carried as a shoulder bag or backpack. Leader with reflective stripes. Your logo will be printed on the bag.

- ✂ ø 23 x 50 cm
- 📦 S1
- 📦 15 x 10



190T POLYESTER



XXL, SOFT GRIP



1529

Umbrella Get seen

Large umbrella which will draw attention to itself and your logo thanks to its black-neon and yellow color contrast (190T polyester.) We print your logo on a segment.

- ✂ ø 123 x 97 cm
- 📦 S1
- 📦 20 x 20

 POLYESTER



 AZO FREE,
REFLECTIVE



3397

Baseball cap Chicago

Baseball cap made of polyester with reflective piping on the visor. We print your logo on the center of the forehead.

 26 × 15 × 11,5 cm
 TT1
 9 × 5

 POLYESTER

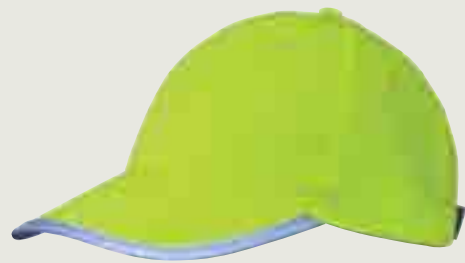

 AZO FREE,
REFLECTIVE



3398

Children's baseball cap Seattle

Kids baseball cap made of polyester with reflective piping on the visor and Velcro closure. We print your logo in the center of the forehead.

 23 × 15 × 10,5 cm
 TT1
 9 × 5

 COTTON

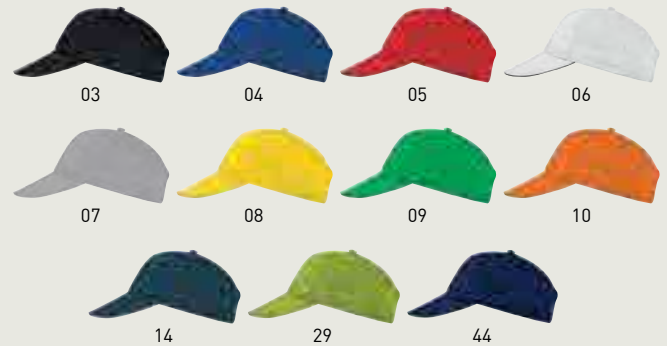

 AZO FREE



0466

6-panel baseball cap San Francisco

Sporty and trendy! 6-panel sandwich baseball cap made of heavy brushed cotton with a matt silver metal snap closure. The sandwich cap comes with a white stripe in the middle of the visor. This cap is very trendy and comes in high-quality heavy cotton. We will embroider your logo onto the front. The price for embroidery is per 1.000 stitches. Standard embroidery requires about 8.000 stitches.

 28 × 16 × 11 cm
 HF
 6 × 4

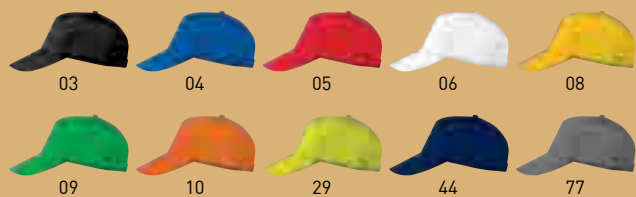

 COTTON



 AZO FREE



2466

5-panel baseball cap Santa Fe

Classic 5-panel baseball cap made of AZO-FREE cotton. Available in bright colours and provided with a velcro closure. Your logo will be printed onto the front.

 28 x 16 x 11,5 cm
 TT1
 9 x 5



 POLYESTER



 AZO FREE



0607

Sandwich cap Arlington

Baseball cap made of 215 polyester with sandwich and velcro closure. We print your logo on the forehead.

 25 x 17 x 11 cm
 TT1
 9 x 5

POLYESTER



0771

Hat Memphis

Hat made of 100% polyester with a colored band on which we print your logo. Please note when you order without print, the band is delivered separately.

✂ 23,5 × 28 × 14 cm
☒ TT1
☒ 10 × 2

POLYESTER

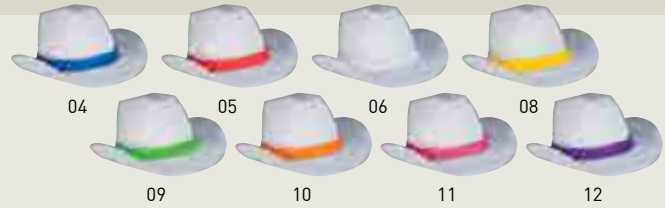

0772

Hat Baldwin

Hat made of 100% polyester with a colored band on which we print your logo. Please note when you order without print, the band is delivered separately.

✂ 27 × 36 × 15 cm
☒ TT1
☒ 10 × 2

STRAW



8797

Straw hat Summerside

It's summer time! A must for every event. Enthuse your clients with this chic straw hat. It provides a sweat band on the inner seam, thus giving you a comfortable feeling when wearing it. Due to its neutral shape, it can be worn by men as well as by women. We will print your logo to the white band.

✂ ø 36 cm
☒ TT1
☒ 10 × 2



ECO



ORGANIC COTTON



AZO FREE



3635

Baseball cap Lyon

Eco-friendly, organic cotton baseball cap with continuously adjustable velcro closure. Your logo will be printed on the front side.

📏 16 × 27 × 12,5 cm

🏷️ TT1

📦 9 × 5



04

08

10



PLASTIC



400 UV
PROTECTION



2465

Sunglasses Nivelles

Sunglasses with UV400 categorie 3 protected, colored glasses and plastic frame. Your logo will be printed on the temple.

📏 14,2 × 15 × 4,7 cm

📏 T3



📏 3,5 × 1

PLASTIC
400 UV
PROTECTION

1428

Sunglasses Woodlook

Sunglasses with UV400 certified lenses and wooden temples. Your logo will be printed on a temple.



-  14,5 × 15 × 4,8 cm
-  T3
-  3,5 × 1

PLASTIC, CORK
400 UV
PROTECTION

2625

Sunglasses Nagoya

Black, classic sunglasses with UV 400 protection, filter category 3, high-quality plastic frame and temples in cork look. Your logo will be printed on a hanger.



-  14,5 × 14,5 × 4,8 cm
-  T3
-  3,5 × 1

PLASTIC
400 UV
PROTECTION

8758

Sunglasses Atlanta

Stylish! Give your logo a modern design with these fancy sunglasses. Please choose the right one for your company out of the various colourful range. The plastic sunglasses with UV 400 certified glasses will be likely worn by your customers and you will prevail with your logo. We will print it by means of pad printing right or left on the earpiece. Single-packed in poly bag.

-  14,3 × 14,3 × 4,8 cm
-  T3
-  3,5 × 1









 600 D POLYESTER REFLECTED

2684

Bicycle bag Murcia

Bicycle bag made of durable 600D polyester with reflective stripes. The bag can be easily attached to the middle frame bar using the brackets and offers sufficient space for all important utensils. We will print your logo on the bag.

-  30 × 7,5 × 19 cm
-  TT1
-  7 × 2







 600 D POLYESTER REFLECTED

2686

Handlebar bag Pompei

Bike bag to attach to the handlebars with a large main compartment, smartphone compartment that can be operated by touch through the film. Reflective strip on the front also draws attention to you. Your logo will be printed on the bag.

-  21,5 × 14 × 16 cm
-  TT1
-  10 × 5





 600 D POLYESTER REFLECTED



2683

Bicycle saddle bag Plymouth

High-quality, large bicycle saddle bag that is attached to the luggage rack. With many functions such as elastic straps and several compartments to stow away. We will print your logo onto the bag.

-  43 × 38 × 41 cm
-  TT2
-  10 × 5



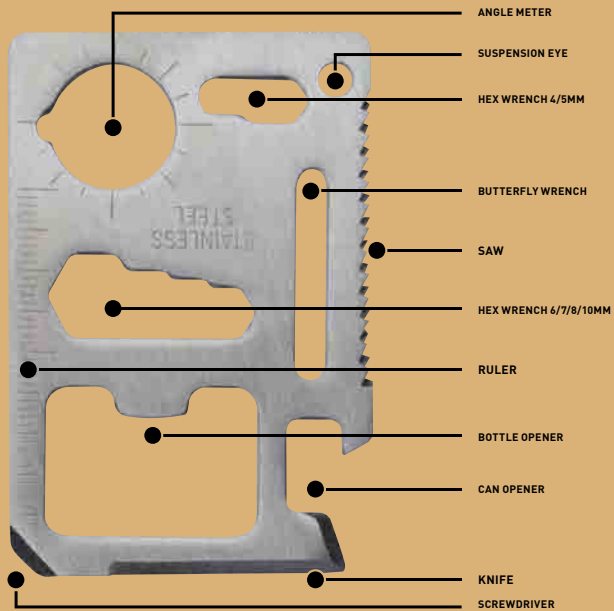

2749

Multitool Rovinj

16in1 multitool made of stainless steel in a pocket shape. The practical companion has the following features: PU case, can opener, knife, screwdriver, bottle opener, ruler, 4 Hex wrenches (6/7/8/10mm), angle meter, 2 Hex wrenches (4/5mm), suspension eye, saw, butterfly wrench. We engrave your logo on the tool.

- ✂ 7,8 × 5,5 × 0,3 cm
- ⊠ L2
- ☞ 1,5 × 1

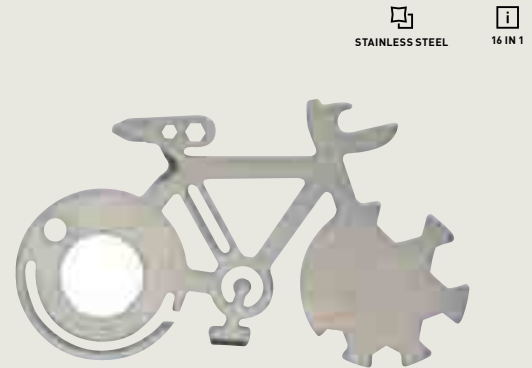
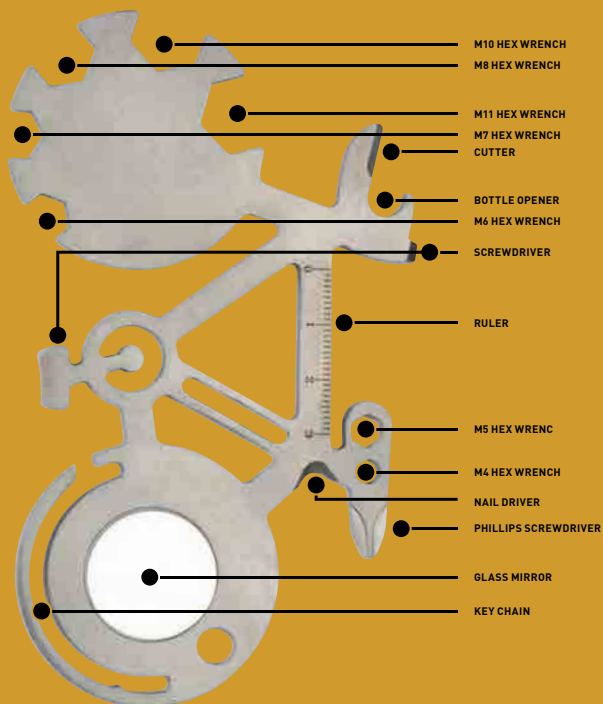

2631

Bicycle multitool Oviedo

The perfect companion on every bike tour. The multitool has 16 different functions such as 7 different wrenches, 3 screwdrivers, bottle openers, etc. We engrave your logo on the tool.

- ✂ 10 × 0,2 × 5,9 cm
- ⊠ L2
- ☞ 2,5 × 1,5

PLASTIC REFLECTIVE, BATTERY INCLUDED



6093

Flashing light clip Cincinnati

Pay attention to yourself! Practical plastic heart shaped flashlight clip, ideal for bikers. 1 coin cell is already included. We will put your logo on the reflective field.

- ✂ 4 × 1,9 × 3,4 cm
- ⊗ T2
- ☞ 2 × 1



PLASTIC, METAL, POLYESTER 24 IN 1



8001

Bike repairing kit Minneapolis

Flat tyre? Loose saddle or front wheel? - No problem with this practical 17-piece bike repairing kit with numerous bits, hex-wrenches, screw-wrench, dismantling key and repair kit in a space-saving case made of robust polyester. We will print your logo on the front handle.

- ✂ 8,2 × 4,4 × 10,9 cm
- ⊗ TT1
- ☞ 5,5 × 3,5

STAINLESS STEEL, PLASTIC 14 IN 1



2693

Bicycle repair kit Rochelle

Bicycle repair kit consisting of two valve tubes, a grater, a tyre lever, two valve caps, five repair patches, a crayon and a wrench. We will print your logo on the box.

- ✂ 12,8 × 6,5 × 2,3 cm
- ⊗ T3
- ☞ 4 × 2



METAL

8 IN 1



1910

Meta screwdriver set Corleone

Metal screwdriver set with eight different bits. We apply your advertising message on the shaft by means of laser engraving.

- ø 1,5 × 10,9 cm
- ⊗ L3
- ⊠ 3 × 0,8



PVC, POLYESTER,
STAINLESS STEEL

20 IN 1



0849

Tool set Essex

The tool set consists of a screwdriver with various nuts and bits, an extension piece, and three hexagonal keys in different sizes, and a practical pouch with snap hooks where we print your logo. The set is individually packed in a polybag.

- 15,2 × 9 × 2 cm
- ⊗ S1
- ⊠ 10 × 3



PLASTIC, METAL

26 IN 1



8002

25-parts tool set Managua

Tool set consisting of various screwdrivers, tweezers, two pliers and a screwdriver with various nuts and bits. We engrave your logo on the lid of the tool set. Doming on request.

- 🔧 15,5 × 10 × 5 cm
- 📏 L3
- 📦 4 × 2



ECO

BAMBOO, METAL

21 IN 1



3168

22-piece tool set Beringen

22-piece tool set consisting of 3 screwdrivers, various bits with adapter, as well as a cutter and 4 hexagonal keys in a bamboo case. Your logo will be engraved onto the case.

- 🔧 22 × 11 × 3,5 cm
- 📏 L3
- 📦 5 × 5





ECO



BAMBOO,
STAINLESS STEEL



9 IN 1

3230

Multifunction tool bamboo Leeds

Multifunction tool made of stainless steel with bamboo shells and various tools such as pliers, knife, saw, screwdriver, file, etc. Your logo will be engraved on one side of the handle.

✂ 7,2 × 3,5 × 1,8 cm

⚙ L2

📏 4 × 0,8



STAINLESS STEEL,
WOOD

13 IN 1



1419

Multi function tools La Libertad

Stainless steel multifunction tool, with chic wooden shells on the handles: large pliers with cutting function, small saw with measuring unit and file, knife, Phillips screwdriver, three screwdrivers in different widths, small knife with cable insulation remover and can opener. The multitool comes in a belt pouch so you can always carry it with you. We will engrave your logo on the handle.

- ✂ 7,8 x 2,7 x 16,5 cm
- ⊗ L3
- ☒ 1,5 x 0,5



STAINLESS STEEL

7 IN 1



0850

Multi-function tool Peer

Multifunction tool (stainless steel) consisting of a hammer, a file, two blades, a saw, a slotted screwdriver and a bottle opener. Included is a matching case on which we print your logo in the center.

- ✂ 15 x 6,5 x 2,9 cm
- ⊗ TT1
- ☒ 6 x 3





 STAINLESS STEEL
  5 IN 1
  FOOD SAFE





0816

Camping cutlery Pamplona

Two-piece camping cutlery made of stainless steel. It can be split in the middle so you get knife and fork, or bottle opener and spoon. We engrave your logo on one side.

 8,6 × 3 × 2,5 cm
 L2
 4 × 1,2



 STAINLESS STEEL
  14 IN 1



2915

Pocket knife Springfield

14-piece pocket knife made of stainless steel consisting of: can opener, scissors, fish hook remover, fish scaler, saw knife, knife, slot screwdriver, can opener, key ring, corkscrew, nail file, reamer and Phillips screwdriver. We engrave your logo on the knife.

 9,9 × 1,5 × 2,5 cm
 L2
 4 × 1



 ALUMINIUM
  BATTERIES INCLUDED,
 10 IN 1, LED,
 HAND WRIST



3414

Set torch & multi-tool Oakland

Perfect duo! Captivate your customers with this nice set consisting of aluminum torch with 9 LEDs and multi-functional pliers. The pliers also provide a nail file, can opener, Phillips screwdriver and two different slotted screwdrivers, knife, saw knife, bottle opener and pricker. We will engrave your logo on the torch. Three AAA batteries are included in delivery. Single-packed in box.

 8,3 × 2,8 × 12,4 cm
 L2
 2,5 × 1



ALUMINIUM



BATTERIES INCLUDED,
13 IN 1, LED,
HAND WRIST



04

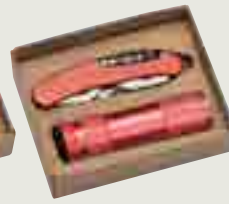

05



07

3372

Set torch and pocket knife Dover

Set consisting of an aluminum flashlight with nine LEDs and a pocket knife. We laser your logo on the flashlight and the pocket knife in the same size. Three AAA batteries included.

- ✂ 13,5 × 8,8 × 3,1 cm
- 🔦 L4
- 🔋 2,5 × 1



STAINLESS STEEL,
ALUMINIUM



7 IN 1



05

04

03

9602

Pocket knife Havana

Handy stainless steel pocket knife with seven parts, including a large blade, can and bottle opener, corkscrew, Phillips and slotted screwdriver and a key ring. We engrave your logo on the aluminum shell.

- ✂ 9,4 × 2,5 × 1,3 cm
- 🔧 L2
- 🔋 3,5 × 1,2



ECO
WOOD, STAINLESS STEEL
11 IN 1



1899

Pocket knife Edirne

11-Part stainless steel pocket knife with 2 saws, scissors, bottle and can opener, corkscrew, rasp, screwdriver etc. covered with wood. Your logo will be engraved on the wooden surface.

✂ 9,2 x 2,3 x 1,8 cm
 ☒ L2
 ☒ 4 x 1

ECO
BAMBOO, WOOD, STAINLESS STEEL
INCLUDE BATTERY, 11 IN 1, HAND WRIST
USB TYPE-C, USB-A
500 MAH

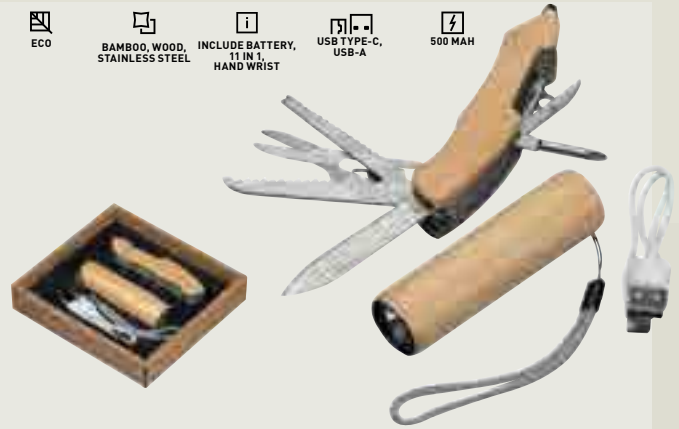

3795

Set Torch + pocket knife Oldham

Attractive set of a torch and a pocket knife. The torch has a bamboo casing and an integrated 500 mAh battery. The pocket knife is equipped with the following functions: Knife, scissors, a bottle opener, a serrated knife, a corkscrew, a nail file, a Phillips screwdriver, a fish scaler, a fish hook remover and a punch awl. Your logo will be laser engraved on both parts in the same size.

✂ 15,7 x 14,5 x 2,9 cm
 ☒ L4
 ☒ 3 x 1



ECO
BAMBOO
HAND WRIST
USB TYPE-C, USB-A
500 MAH



3733

Torch Dundee

Bamboo torch with integrated 500 mAh battery and USB-C charging cable. We print your logo to the lamp by laser engraving.

✂ ø 2,3 x 8,6 cm
 ☒ L2
 ☒ 5 x 1,5



ALUMINIUM, ABS

COB LIGHT,
HAND WRIST



1374

COB light Watford

Handy COB working light made of plastic with additional lamp on the side, safe stand and carrying handle. We print your logo on the back.

➤ 9,5 × 3,5 × 13 cm
⚙ T4
📦 4 × 3



ALUMINIUM, GLASS

COB LIGHT,
HAND WRIST



03

04

05

07

09

1904

6 COB metal torch Montargis

COB aluminum flashlight with six COB's. We apply your logo by means of a laser engraving on the center piece. Excluding three AAA batteries [order them immediately, see last page or article 999400].

➤ ø 2,5 × 8,8 cm
⚙ L2
📦 2,5 × 1



ABS, STEEL BATTERIES INCLUDED, LED

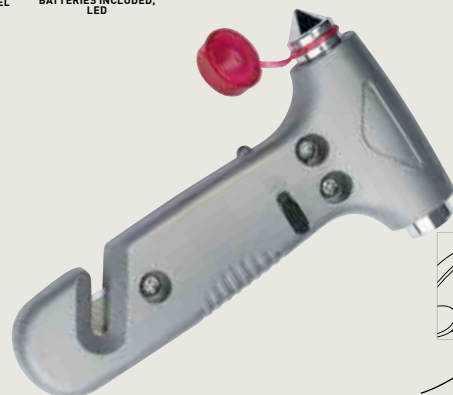

2664

Emergency hammer Valencia

Guardian angel for emergencies. Safety emergency hammer with LED light, integrated belt cutter and a rubberized protective cover. Your logo will be printed on the hammer.

➤ 7,5 × 2,3 × 13 cm
 ☒ T3
 ☒ 3 × 1

PLASTIC

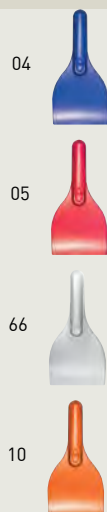

9012

Plastic ice scraper Hull

Ice scraper made of plastic (PS) in frosted look with large advertising space. We print your logo in the center of the ice scraper.

➤ 22,2 × 10,8 × 2,9 cm
 ☒ T3
 ☒ 5 × 3

ABS 4 IN 1, BATTERIES INCLUDED, LED, EMERGENCY HAMMER, SEATBELT CUTTER



0483

4in1 Ice scraper Snowdon

4in1 ice scraper made of ABS. The ice scraper works also as a belt cutter, glass hammer or, thanks to its 3 LEDs, as a flashlight. We print your logo centered on the scraper.

➤ 28,5 × 9,8 × 3,5 cm
 ☒ T3
 ☒ 5 × 2



PLASTIC, METAL



1547

Cutter knife Warehouse

Indispensable cutter knife - with stable metal housing. The blade can be changed several times. We print your logo on the back.

- ✂ 14,5 × 1,5 × 2,7 cm
- ✂ T2
- 📦 4 × 1



PLASTIC, METAL



2095

Cutter Dendermonde

Professional Cutter with firm grip, adjustable wheel and a removable blade. Your logo will be printed on the back.

- ✂ 15,2 × 1,7 × 3,7 cm
- ✂ T3
- 📦 4,5 × 1,2



STAINLESS STEEL, ABS



04 05 06 08 10

9003

Small cutter San Salvador

This cutter has the same functions as item 9001, but is smaller and you can break the blade up to 12 times. These cutters are really used by everyone, no matter if at home or work. Your logo will be recognized a thousand times. Printing on the back of the cutter.

- ✂ 13,4 × 1,4 × 1,4 cm
- ✂ T2
- 📦 5 × 0,6



STAINLESS STEEL, ABS



04 05 06 08 09

9001

Big cutter Quito

Cardboard knife made of plastic with snap-off blade (seven blade parts). We print your logo on the closed part of the plastic case.

- ✂ 15,3 × 3 × 1,4 cm
- ✂ T2
- 📦 5 × 1



3245

Garden tool set Montpellier

Handy garden helper! Cotton belt with click closure, rake and two different sized shovels. Your logo will be printed on the belt.

✂ 17,5 × 14,5 × 2,5 cm

☒ S1

☒ 12 × 2



ECO



WOOD



2 M



2967

Folding rule St. Gallen

Wooden folding rule with a measuring range of up to 2 meters. Your logo will be printed on the folding rule.

🔧 23,7 × 2,9 × 1,6 cm

📦 T2

📏 6 × 2,5

PLASTIC,
STAINLESS STEEL

HAND WRIST

3M



1736

3 meter steel measuring tape Denver

Steel measuring tape with a measuring length of 3 meters, locking slide, quick-release button and hand strap. The rubber finish ensures a particularly pleasant feel. We print your logo on the silver emblem.

↗ 6,7 × 6,1 × 2,5 cm
⊗ T3
☒ 3,5 × 1,5

PLASTIC,
STAINLESS STEEL

HAND WRIST

5M



1737

5 meter steel measuring tape Kentville

Steel tape measure with a measuring length of 5 meters, locking slide, quick release button and hand strap. The rubber finish ensures a particularly pleasant feel. We print your logo on the silver emblem.

↗ 7,3 × 6,7 × 3,5 cm
⊗ T3
☒ 3,5 × 1,5

PLASTIC

0,5M

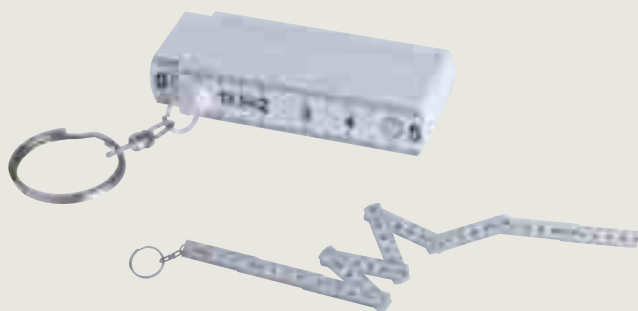

1355

Keyring with 0,5m ruler

Keyring with fold-out plastic ruler with up to 0.5 metres measuring range. Your logo will be printed on the ruler.

↗ 6,4 × 2,4 × 1,3 cm
⊗ DC1
☒ 4,5 × 2,1

ABS, METAL

1M



8808

Steel measuring tape Aberdeen

The Quintessential measuring tape!. This key ring with a handy 1 m measuring tape is always there when you need it as it fits in every pocket. We will print your logo onto the cover.

↗ 4 × 4 × 1 cm
⊗ T2
☒ 3 × 3



METAL



BOTTLE OPENER



2260

Metal bottle opener Hastings

Chrome plated metal bottle opener with keychain. We apply your logo by engraving.

- ✂ 8,2 × 3,2 × 0,8 cm
- ⊗ L2
- ⊞ 3 × 1,5



PLASTIC,
STAINLESS STEEL



BOTTLE OPENER,
BOTTLE CLOSURE



04



05



06

3020

Fist bottle opener Luton

Classic bottle opener with bottle cap. We apply your logo on the bottle opener by pad printing.

- ✂ 9,4 × 4,1 × 1 cm
- ⊗ T2
- ⊞ 4 × 3



METAL

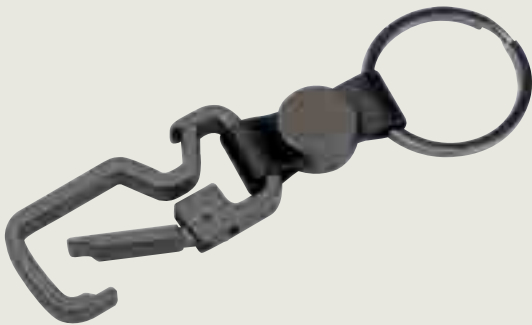

3656

Keyring Macau

Graphite-coloured keyring with carabiner, key ring and bottle opener. Your logo will be engraved on the round piece.

- ✂ 11,6 × 3,5 × 0,6 cm
- ⊗ L2
- ⊞ ø 1





03

04

05

07

09

10

9042

Metal bottle opener Worcester

A bottle opener as a key ring. Simple and functional! Your logo will be laser-engraved on the bottle opener.

✂ 5,5 × 1 × 0,3 cm

☒ L1

☑ 3 × 0,8



☑ METAL

☑ BOTTLE OPENER



☑ ECO

☑ RECYCLED ALUMINIUM

☑ BOTTLE OPENER



3764

bottle opener Malmö

Bottle opener made of recycled aluminium including a key ring. We will laser engrave your logo on the pendant.

✂ 8,9 × 2,9 × 0,2 cm

☒ L1

☑ 3 × 1



03

04

05

07

09

10



PLASTIC

BATTERIES INCLUDED, ALARM



0845

Pocket alarm Ovada

The pocket alarm can be activated by simply pulling out the pin on the keyring. Thanks to the two included safety hooks, it can be fastened almost anywhere. Includes a black drawstring and three LR45 button cells. We print your logo on one side.

✂ 6 × 4 × 1,9 cm
 ⚙ T2
 📦 2 × 1,5



ABS, METAL

BATTERIES INCLUDED, LED



2311

Plastic key ring Bath

Flat and rectangular key fob in a modern design and LED light inside. The key ring is made of metal. 2 batteries are included. We will print your logo on the opposite side of the button.

✂ 9,6 × 2,4 × 0,8 cm
 ⚙ T2
 📦 4 × 1



ECO

BAMBOO

LED,
3 BUTTON CELL
INCLUDED



3785

Torch Mallorca

Bamboo torch with key ring. Three button cell batteries are already included in the delivery. We print your logo to the lamp by means of laser engraving.

✂ ø 1,4 × 6,5 cm
 ⚙ L2
 📦 5 × 1,5

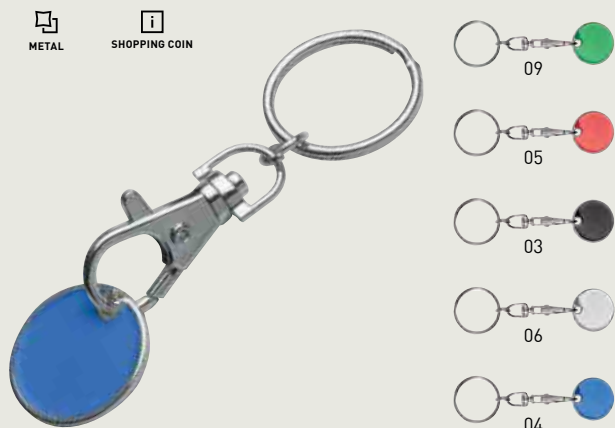

0477

Keyring with shopping coin

Metal keyring with snap hook and shopping coin. One side of the coin is colored. We will engrave your logo onto the silver side.

- ✂ $\varnothing 2,5 \times 8,3$ cm
- ⊗ L2
- ☒ 1 x 1



1583

Keyring with shopping cart chip Stickit

Stainless steel keychain with integrated shopping cart chip, key ring and bottle opener. Your logo will be lasered on the fob.

- ✂ $6 \times 2,3 \times 0,2$ cm
- ⊗ L2
- ☒ 4 x 1



3736

Keychain Gothenburg

Bamboo key ring with integrated shopping trolley chip and key ring. We will laser engrave your logo on the key ring.

- ✂ $9,5 \times 2,3 \times 0,2$ cm
- ⊗ L2
- ☒ 4 x 2



METAL



8661

Key ring Flint

Rectangular! This metal key ring is perfect for your logo. Now you can choose how your logo should be made. Choose between a laser engraving and doming (CMYK). We will print your logo onto the key ring. Single packed in a cardboard box.

- ✂ 3 × 0,4 × 8 cm
- 📏 L2
- 📦 3,5 × 2,5



METAL

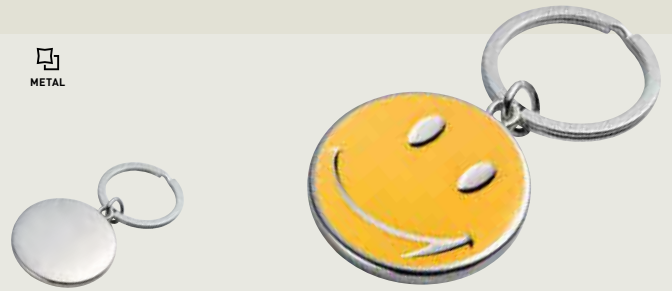

3474

Key ring Smile

Keep on smiling! Give your clients a smile with this jolly metal key ring. We will place your logo on the shiny part by means of laser engraving. Single packed in black gift box.

- ✂ 7,5 × 3,7 × 0,5 cm
- 📏 L2
- 📦 ø 3,5



METAL



1269

Keyring Supercar

Elegant metal key ring with carbon-look strap. Your logo will be engraved on the chromed surface.

- ✂ 9,5 × 2,2 × 0,8 cm
- 📏 L2
- 📦 2,5 × 1,5



METAL

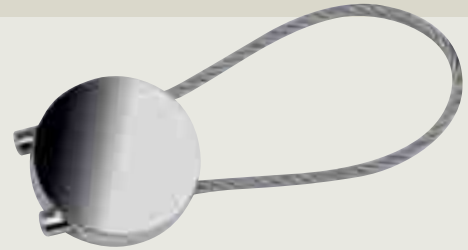

1426

Key ring Namur

Round metal keyring with wire ring. We will laser your logo on the round surface.

- ✂ 2,6 × 0,6 × 7,2 cm
- 📏 L2
- 📦 2 × 2



METAL



2108

Slender metal key ring Slim

Chic keychain made of matte and shiny metal. We engrave your logo on the matte center piece. Doming possible on request.

- ✂ 8 × 3,5 × 0,6 cm
- 📏 L2
- 📦 2,7 × 0,9



METAL



0578

Keyring Penrith

Keychain made of a combination of metal and imitation leather with keyring. Your logo is engraved on the metal surface.

- ✂ 9,4 × 3,5 × 0,5 cm
- 📏 L2
- 📦 3 × 1,5



0645

Keyring Massachusetts

Rectangular keychain made of beech wood with key ring. Laser engraving makes your logo stand out perfectly.

- ✂ 8,7 × 3,4 × 0,8 cm
- 📏 L1
- 📦 4 × 3



0644

Keyring Bern

Round beech wood keychain with key ring. Through a laser engraving your logo comes ideally to the fore.

- ✂ ø 4,4 × 7,9 × 0,9 cm
- 📏 L1
- 📦 ø 2,5



2769

Cork keychain Watersports

Shapely key ring made of cork with additional benefits. Due to its natural buoyancy, the trailer protects your keys from being lost, e.g. while sailing, fishing and all other water sports. We engrave your logo on the trailer.

- ✂ 9 × 4,1 × 1,5 cm
- 📏 L2
- 📦 5 × 2



3708

Bamboo Pendant Salamanca

Eco-friendly bamboo pendant with cord for hanging. Your logo will be engraved on the pendant.

- ✂ 3,5 × 0,3 × 5,4 cm
- 📏 L1
- 📦 4 × 1



1489

Metal-Wooden keyring Baltrum

Elegant keyring made of metal with a wooden insert on which your logo will be engraved.

- ✂ 8,5 × 2,6 × 0,5 cm
- 📏 L2
- 📦 3 × 1,2

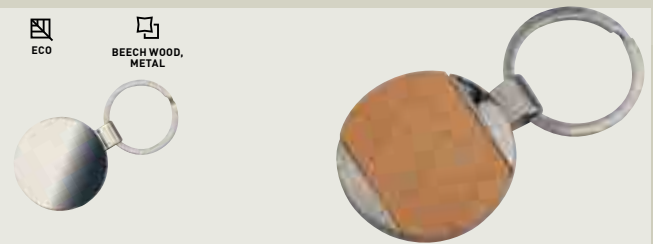

1397

Metal-Wooden keyring Langhaus

Elegant keyring made of metal with a wooden insert on which your logo will be engraved.

- ✂ 7,5 × 4 × 0,4 cm
- 📏 L2
- 📦 3 × 1,5



PLASTIC



04



05



09



66

6235

Piggy bank Leicester

Save your money! You can make small dreams come true with this cute piggy bank in 7 different colours, but it is also very decorative on your desk. We will print your logo on one side of the piggy bank. Packed individually in a cardboard box.

✂ 12,6 × 10 × 10,1 cm

☒ T4

☑ 4 × 2,5



PLASTIC



CREDIT CARD SIZE,
MAGNIFIES 3x

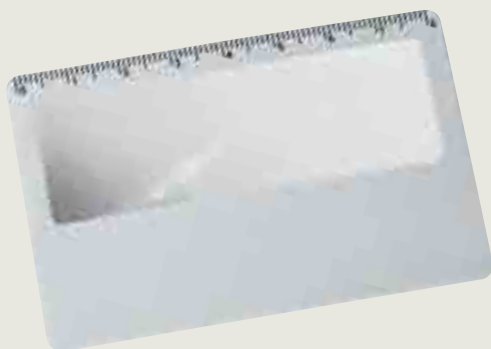

1998

Credit card sized reading lens Posen

This small reading lens can be used everywhere and is very practical because of its size. It is a perfect mailing item and provides plenty of space for your logo. Comes in a poly bag. We will print your logo on the space below the lens.

✂ 8,6 × 5,5 cm

☒ T2

☑ 5 × 1,5



PLASTIC



LED LIGHT,
MAGNIFIES 3x



2238

Magnifying glass with LED Gloucester

Magnifier made of plastic with triple magnification and a built-in LED. We print your logo on the handle. The scope of delivery already includes a button cell.

✂ 14,8 × 6,4 × 1,1 cm

☒ T3

☑ 4 × 1,5



ALUMINIUM

RFID PROTECTION



0417

RFID Card holder Gladstone

Aluminum card holder with RFID (Radio Frequency Identification) protection against the unauthorized reading of e.g. credit cards, bank cards, identity card etc. The logo is lasered on the case.

- ✂ 9 × 5,8 × 0,6 cm
- 📏 L2
- 📏 5 × 3

PLASTIC

RFID PROTECTION



0831

RFID Business card holder Edinburgh

RFID card case, protects against data theft and provides space for two cards. We print your logo on the case.

- ✂ 9 × 6,1 × 0,1 cm
- 📏 T3
- 📏 5 × 3

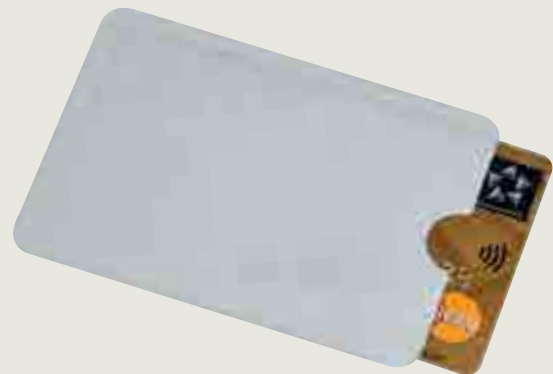



ABS, METAL



ADJUSTABLE FLAME,
REFILLABLE,
JET FLAME



03

06



1392

Electronic lighter Stromflame

Refillable electronic lighter with black head and adjustable jet flame. Your logo will be printed on one side.

➤ 2,5 × 1,2 × 7,9 cm

⚙ T2

📦 5 × 1,5



ABS, STEEL



RECHARGEABLE



USB-A

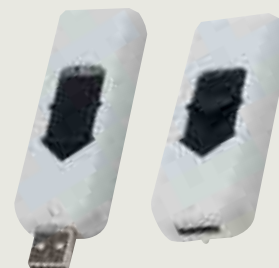

0977

USB lighter Bebington

USB lighter made of plastic with a incandescent spiral that is simply charged via the integrated USB connector and works without gas. Your logo will be printed on the lighter.

➤ 7,9 × 2,7 × 1,6 cm

⚙ T2

📦 3,5 × 2

PLASTIC, METAL
ADJUSTABLE FLAME,
REFILLABLE



1106

Electronic lighter Lichtenstein

Chique! This beautiful electronic lighter (refillable) can be used from everybody. Lighters change very often the owners - that way your logo will be seen everywhere. We print your logo on the surface. This lighter has a children protection.

- ✂ 2,5 × 1,1 × 8,2 cm
- 🔍 T1
- 📏 5 × 1,4

PLASTIC, METAL
ADJUSTABLE FLAME,
REFILLABLE

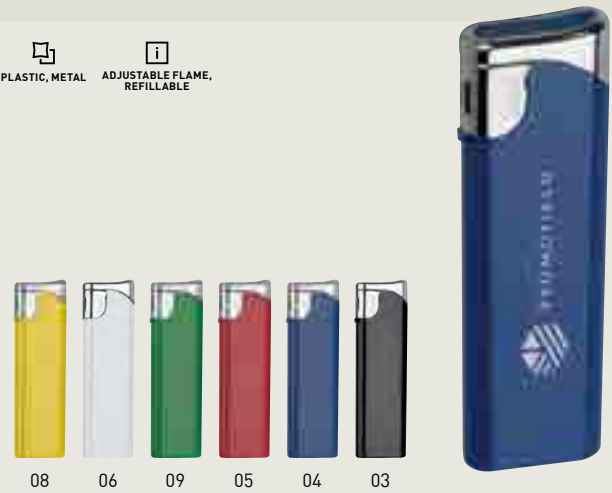

7552

Electronic lighter Knoxville

Refillable electronic lighter made of plastic. Of course, this model has the mandatory child safety lock. We print your logo on one side of the lighter.

- ✂ 2,4 × 0,9 × 8,2 cm
- 🔍 T1
- 📏 5 × 1,4

PLASTIC, METAL
ADJUSTABLE FLAME,
REFILLABLE



0046

Electronic lighter

Electronic plastic lighter with flame regulation and refillable function. We will print your logo onto the lighter.

- ✂ 2,9 × 1,6 × 8,6 cm
- 🔍 T1
- 📏 5 × 1,4

PLASTIC, METAL
ADJUSTABLE FLAME



1107

Disposable lighter Karlsruhe

The classic one of the lighters. Surprise your customer with this cheap logoal product. The surface, where we print, is huge enough to tell your customers your message. This lighter has a children protection. We print your logo on the surface.

- ✂ 2,8 × 1,6 × 8,6 cm
- 🔍 T1
- 📏 5 × 1,4



 PLASTIC, METAL
  ADJUSTABLE FLAME,
REFILLABLE,
RUBBER COATED



3777

Electronic lighter Mouscron

Ergonomic shaped electronic lighter in fresh colors, refillable. The flame is infinitely adjustable. Your logo will be digitally printed (multi-colored) so that it is readable for right-handers.

✂ 2,5 × 1,5 × 8,3 cm

⊠ DC0

⊠ 6 × 1,4

PLASTIC, METAL

ADJUSTABLE FLAME,
REFILLABLE

0045

Creme Brulee torch

Refillable "creme brulee" torch with regulabe flame size and kids security. We will print your logo onto the shaft.

- ✂ 6 × 3,5 × 11,2 cm
- ⊗ T3
- ☑ 5 × 1,2



STAINLESS STEEL

ADJUSTABLE FLAME,
REFILLABLE

6016

Metal stick lighter Brisbane

This slim table lighter is ideal for safely lighting candles, grill, storm lights and many other items. The lighter is refillable and looks extremely good on the table.

- ✂ 17,6 × 1,5 × 1,1 cm
- ⊗ L2
- ☑ 4,5 × 1



PLASTIC, METAL

ADJUSTABLE FLAME,
REFILLABLE

3167

Lighter with attachment for candles Beijing

Electronic lighter with black head and jet flame, refillable. The flame size is infinitely variable. Your logo will be printed on one side.

- ✂ 2,5 × 1,18 × 12,2 cm
- ⊗ T1
- ☑ 5 × 1,8



03

06

 POLYESTER, PLASTIC



3638

Festival bracelets

Polyester event wristband with safety clasp in many different colors. The closure has barbs on the inside, which allows it to be pulled tight but not pulled open. Your logo will be printed on the wristband.

 17 x 1,5 x 0,8 cm

 S1

 10 x 1



 ABS, METAL

 54 CM



1171

Keyring with carabiner and clip Employee

Keyring with a small snap hook, belt clip, and pull-out keyring. Your logo will be printed on the coloured plastic area.

 8,7 x 3,4 x 1,5 cm

 T2

 2,3 x 1,5



ECO



POLYESTER,
PLASTIC,
NYLON

5203

Lanyard Nagasaki

Individual! Design your lanyard according to your ideas. The choice is yours:
Material: Polyester, Satin, Nylon, Soft Polyester. Size: 2 cm band width, 10 cm to plug-in closure, 89 cm circumferential print area. Printing area: 18 mm x 890 mm. Logo application: screen printing, transfer printing, offset printing, weaving. Colors: according to Pantone. Components: see A to J. Minimum quantity 250 pieces. Benefit from our extremely fast delivery time of approx. 1 to 4 weeks. Prices on request. If you have any questions, we will be happy to advise you.

- ✂ 90 x 2 cm
- 🏭 OEM1
- 📦 allover

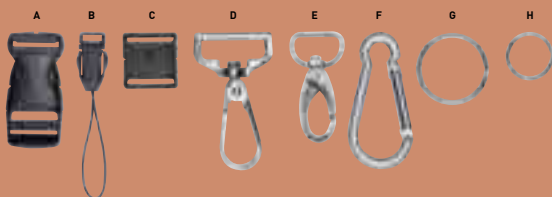

ART. 1591



ART. 1589



3631

Lanyard Maranello

Cork lanyard with carabiner and separable safety clip. Your logo will be printed on the lanyard.

✂ 49 × 2 × 0,2 cm

☒ TT1

📦 10 × 1



3645

Lanyard Mannheim

Lanyard made of eco-friendly cotton with carabiner. Your logo will be printed on the lanyard.

✂ 48 × 2,5 × 0,3 cm

☒ S1

📦 18 × 1,5

